

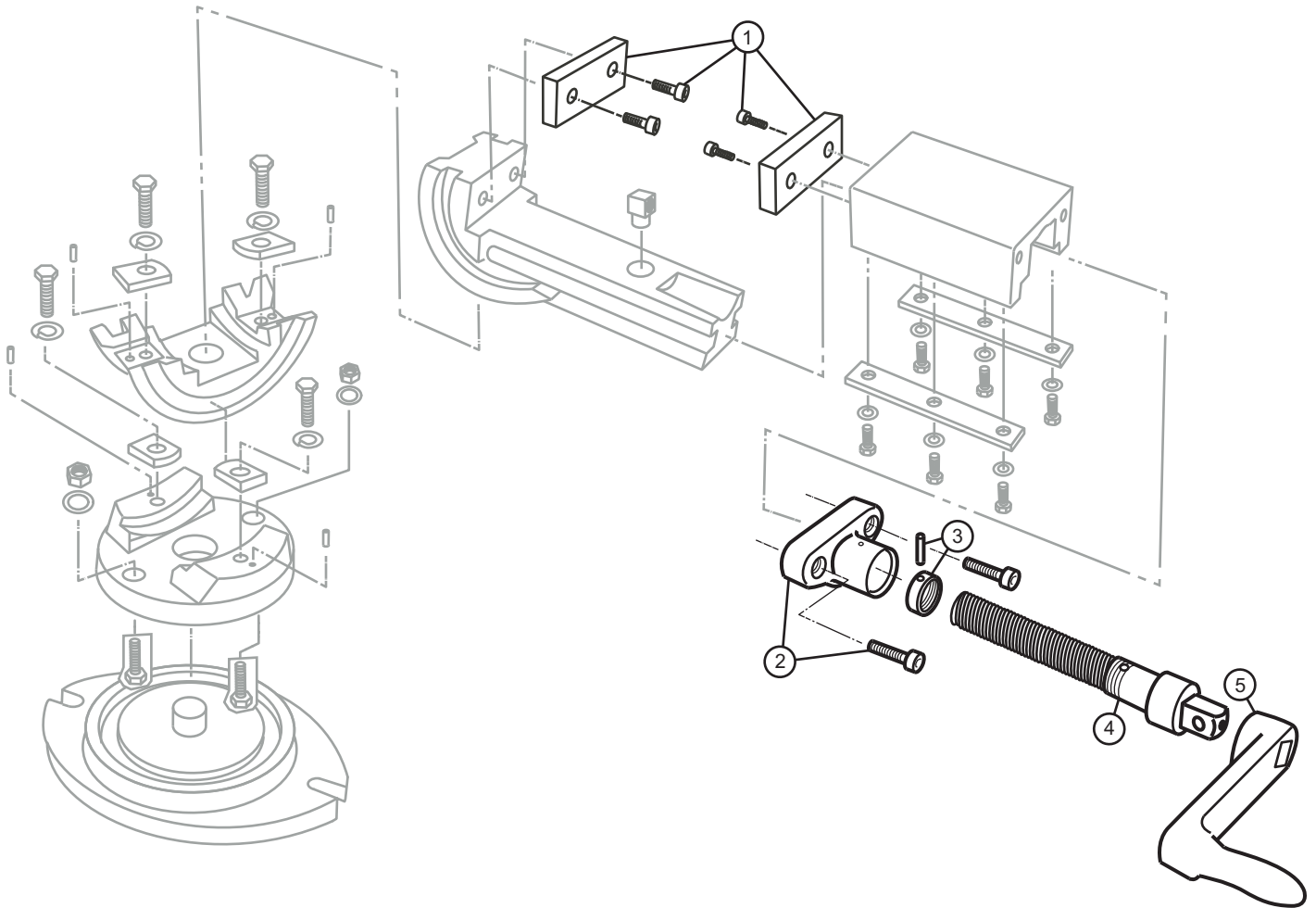

Super Precision 3-Axis Tilting Machine Vise Parts Diagram

3" Jaw Width, 3" Jaw Opening, 1-5/16" Jaw Depth

Stock #: 11701 Model #: TLT/SP-75



#	Part	Description
1	11701-01	Jaw Insert Assembly
2	11701-02	Sleeve and Socket Head (2)
3	11701-03	Collar and Roll Pin
4	11701-04	Clamp Screw
5	11701-05	Handle