



31-122, 31-125, 31-126,
31-131, 31-132
12" DISC FINISHING MACHINE

AFM-5A

416-02-651-0003

Revised 12-10-85

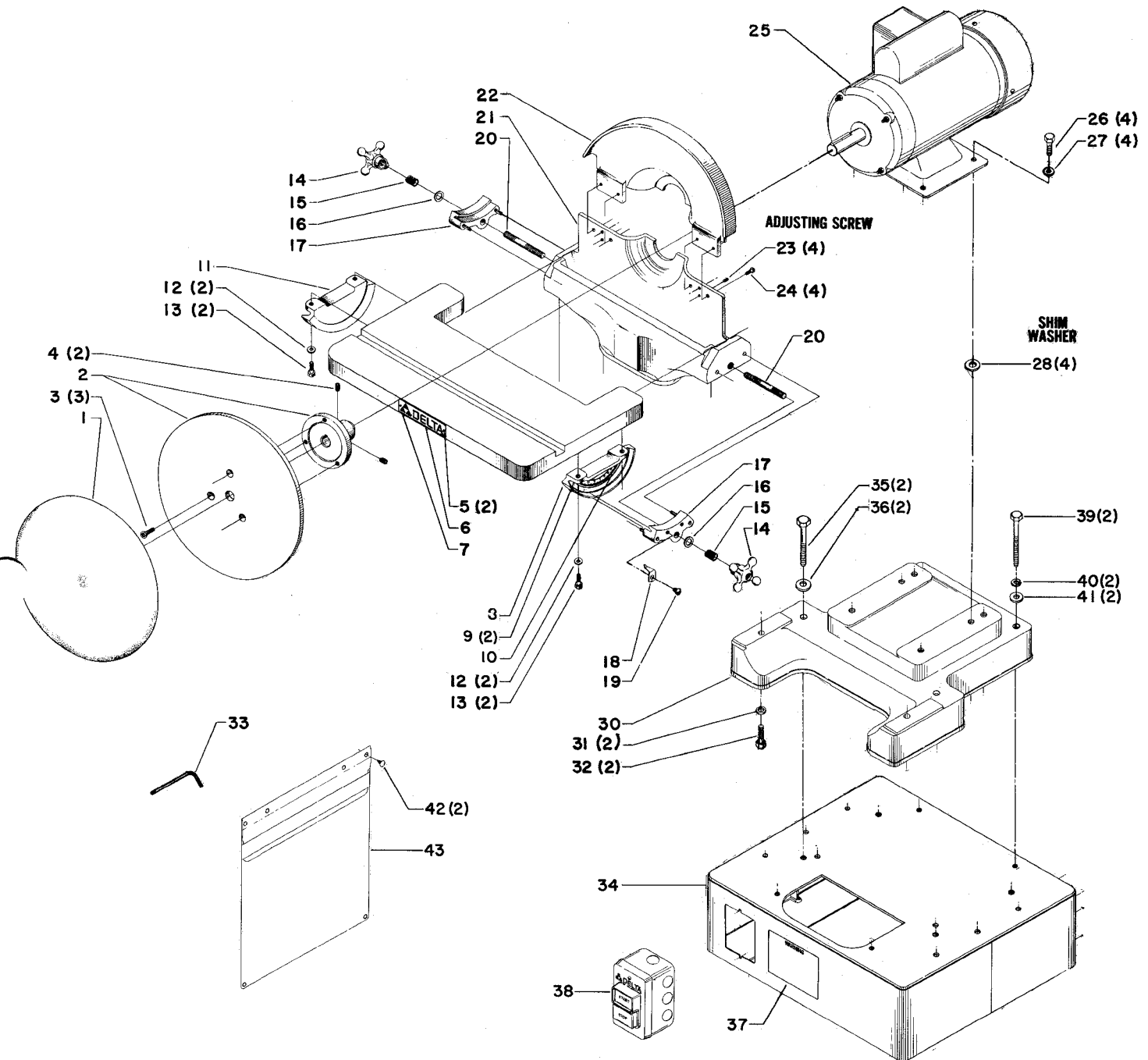

Parts List for 31-125 Type 1

Item Number	Part Number	Description	Qty Required
2	000000-00	No Longer Available	1
3	901030300761	SCREW	3
4	901041500206	SET SCREW	2
5	901064502250S	DRIVE SCREW	2
6	000000-00	No Longer Available	1
7	909075	DISK TABLE	1
8	000000-00	No Longer Available	1
9	901064502250S	DRIVE SCREW	2
10	951020107820	TILT SCALE	1
11	000000-00	No Longer Available	1
12	5140010-69	WASHER	4
13	901010600612S	CAP SCREW	4
14	000000-00	No Longer Available	1
15	928010214125	SPRING	1
16	904010312925	SPEC WASHER	1
17	910984	CLAMP	1
18	422040755001S	POINTER	1
19	901020100502	MACHINE SCREW	1
20	420011110003	STUD	1
21	416020540002	TABLE SUPPORT	1
22	000000-00	No Longer Available	1
23	901041213603	SCREW	4
24	000000-00	No Longer Available	4
25	82-041	MTR 1PH 1HP DP17	1
26	901010600607S	SCREW	4
27	904010101604S	STEEL WASHER	4
28	904100312097S	SPECIAL WASHER	4

Parts List for 31-125 Type 1

Item Number	Part Number	Description	Qty Required
30	416020050003	BASE	1
31	904020201704S	LOCK WASHER	2
32	901010600642	CAP SCREW	2
33	802876	ALLEN WRENCH	1
35	000000-00	No Longer Available	2
36	904010101606S	STEEL WASHER	2
37	406007520002	WARNING DECAL	1
38	000000-00	No Longer Available	1
38	52-348	MAG STAR-STP SWI	1
39	901010603118	CAP SCREW	2
40	904020101703S	LOCK WASHER	2
41	491956-00	WASHER	2
42	400060790001	RETAINER	2
43	400066030003S	ENVELOPE	1