

FOR USE WITH LVC MODELS ONLY

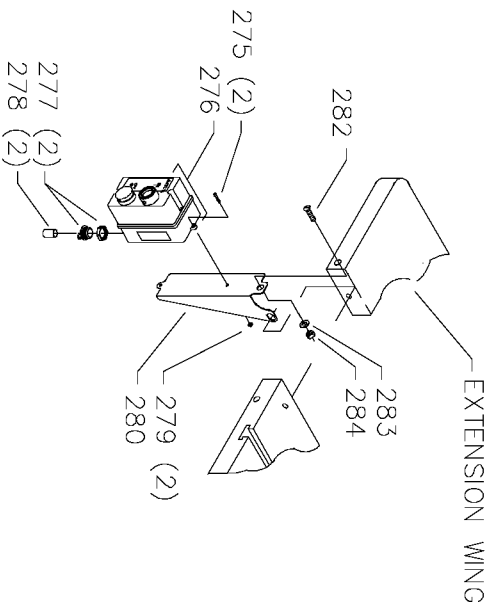

FOR USE WITH GPE MODELS ONLY

Parts List for 34-807 Type 2

Item Number	Part Number	Description	Qty Required
1	1086334S	SEE THRU GUARD	1
1	1086935	BLADE GUARD	1
1	734639	SEE THRU BL GD	1
1	000000-00	No Longer Available	1
2	1086388S	PUSH NUT CAP	1
3	1087811S	PIN	1
5	1086353S	SPRING	1
6	422160470001S	KICK BACK FINGER	2
7	422040710007S	PIN	1
8	1086337S	PIVOT BRACKET	1
9	1086387S	PUSH NUT	1
10	905010106729S	PIN	1
11	422040860002S	SPLITTER W/BUSHING	1
12	901010600649S	CAP SCREW	1
13	904010101620S	WASHER	1
14	904020101703S	LOCK WASHER	2
15	422040140052S	SPLITTER BRACKET	1
16	422040890003S	SUPPORT ROD	1
17	422040140053S	BRACKET	1
18	901010600649S	CAP SCREW	2
19	902010201226S	NUT	1
20	904030201751	LOCK WASHER	1
21	422030720001S	PLATE	1
22	422040140037S	SPLITTER BRACKET	1
23	904010101620S	WASHER	2
24	901030131698S	CAP SCREW	1
25	901030100757S	CAP SCREW	1

Parts List for 34-807 Type 2

Item Number	Part Number	Description	Qty Required
26	34-895	MITER GAUGE	1
40	A24617S	10INUNIV WING	1
40	438010110077S	PLUG	3
41	901010609964	SCREW	3
42	904100312097S	SPECIAL WASHER	3
55	34-154	STD INS 10IN CONT SW	1
56	901044615297	SCREW	4
60	422043910003S	TABLE	1
65	000000-00	No Longer Available	1
66	1087794	RIVET	2
67	422041320004	TILT SCALE	1
68	1087794	RIVET	4
69	422041370014	NAMEPLATE	1
69	422041370013	WARNING LABEL	1
69	422041370012	NAMEPLATE	1
70	422043310014	MOTOR COVER	1
71	410090160004S	BUMPER	1
71	422041220005S	SPRING CLIP	1
71	422041220004	SPRING CLIP	1
71	904010131868S	WASHER	1
71	901024531123S	SCREW	1
72	400064160003	GASKET	1
72	400064160001	GASKET	1
74	000000-00	No Longer Available	1
75	406120260001S	DUST CHUTE	1
76	901052131498	SCREW	4
77	438010110021	INSULATOR	1

Parts List for 34-807 Type 2

Item Number	Part Number	Description	Qty Required
80	438010110065	PLUG	1
81	438010110074	HOLE PLUG 2 DIA	1
82	901030101487	SCREW	4
82	904100312097S	SPECIAL WASHER	4
82	904030301771S	WASHER	4
83	901110200834S	CARRIAGE BOLT	4
85	422043050001	SUB BASE	1
88	902015031514	FLANGED HEX NUT	4
89	901052131498	SCREW	4
90	422350140002S	RIP FENCE HOLDER	2
91	000000-00	No Longer Available	1
101	902012009848S	ARBOR NUT-LH	1
102	422041035001S	FLANGE	1
103	422043030003S	ARBOR & FLANGE	1
104	927030202660S	KEY	1
105	1086894S	BEARING	2
106	928060207382S	LOAD SPRING	1
107	422041040002S	SPACER	2
108	422041300003S	ARBOR PULLEY	1
109	A10686	SCREW	2
110	902070207176S	BEARING CLOSURE NUT	1
112	902012009847S	SPECIAL NUT	1
113	422043145002S	ARBOR BRACKET	1
113	422043145003S	ARBOR BRACKET	1
114	904020201704S	LOCK WASHER	2
115	901010603102S	CAP SCREW	1
116	904151017147S	RET RING	2

Parts List for 34-807 Type 2

Item Number	Part Number	Description	Qty Required
117	927030102653S	KEY	1
118	422043145004	MOTOR BRACKET	1
119	928060114128S	SPRING WASHER	2
120	905010105072	ROLL PIN	1
121	927030102657S	KEY	1
125	5140043-25	3V-BLTS 4L 261/16	1
126	41-644	HD 3GROOVE PULLY	1
127	A10686	SCREW	2
130	904100312097S	SPECIAL WASHER	1
130	904030301771S	WASHER	1
131	901010600664S	CAP SCREW	1
132	422040715001S	STEEL PIN	1
133	422040795001S	SPRING CLIP	2
134	422040365001	DEFLECTOR	1
135	422041045005	SLEEVE	2
136	901010600613	MACHINE SCREW	2
137	422041025002	YOKE	1
138	422040140051S	TRUNNION BRACKET	1
139	901030100775S	CAP SCREW	2
141	901010600682	CAP SCREW	2
142	904020201704S	LOCK WASHER	2
143	902010101207	HEX NUT	2
144	905010102734	ROLL PIN	2
145	422043955002	REAR TRUNNION	1
146	920750113934	BEARING	1
150	422040740001S	PLUG	2
151	422044120009S	LOCK KNOB	1

Parts List for 34-807 Type 2

Item Number	Part Number	Description	Qty Required
151	422044120011	LOCK KNOB	1
152	904010213577S	FIBER WASHER	1
153	905010102706S	ROLL PIN	1
154	422044065002	RAISING SHAFT	1
154	A09527S	SS/A-ELEV SHAFT/GEAR	1
155	902012101036S	HEX NUT	1
156	434014040001	COLLAR W SCRW	1
157	901041500206	SET SCREW	1
158	927030102650S	KEY	1
159	SSF-616-ZN	SCREW .313-24X1.00 H	1
160	902010201228	HEX JAM NUT	1
161	905010102734	ROLL PIN	2
162	904020201704S	LOCK WASHER	2
163	901030100775S	CAP SCREW	2
164	422043955001	FRONT TRUNNION	1
165	920750113935S	BUSHING	1
166	422044000005S	HANDWHEEL	1
166	422044000007	HANDWHEEL	1
167	901041500206	SET SCREW	1
168	904070105569	FIBRE WASHER	1
169	901030408016S	CAP SCREW	1
171	422040145001	FRONT BRACKET	1
172	901010600682	CAP SCREW	2
173	904020201704S	LOCK WASHER	2
174	902010101207	HEX NUT	2
175	927030102650S	KEY	1
176	422044065001S	TILT SHAFT W/WORM	1

Parts List for 34-807 Type 2

Item Number	Part Number	Description	Qty Required
177	904100314509S	COLLAR	1
178	904010213577S	FIBER WASHER	2
179	905010102706S	ROLL PIN	2
180	422040740001S	PLUG	2
181	422044120009S	LOCK KNOB	1
181	422044120011	LOCK KNOB	1
182	422040550006	GUIDE BLOCK	1
183	904100312097S	SPECIAL WASHER	1
184	901010600681	CAP SCREW	1
185	422040142008S	POINTER BRACKET	1
186	919714	SHEET MTL SCR	2
187	904070105569	FIBRE WASHER	1
188	422044000005S	HANDWHEEL	1
188	422044120011	LOCK KNOB	1
189	901041500206	SET SCREW	1
190	422040750002	POINTER	1
191	901061103036	SELF-TAP SCREW	1
192	438010040054	CABLE TIE	1
195	422391010001S	BOX-END WRENCH	1
196	955010501472	OPEN-END WRENCH	1
197	438023146201	1PH 3HP 230V MOTOR	1
197	438023146200	1PH 5HP 230V MOTOR	1
197	83-621	MTR 1PH 1.5HP TS10	1
197	438023146202	3PH 5HP 230V MOTOR	1
197	438023146200	1PH 5HP 230V MOTOR	1
197	438023146201	1PH 3HP 230V MOTOR	1
197	438023146202	3PH 5HP 230V MOTOR	1

Parts List for 34-807 Type 2

Item Number	Part Number	Description	Qty Required
250	1340100	SWITCH COVER ASSY	1
251	901020100567S	MACHINE SCREW	2
252	402071045007S	SPACER	2
253	438010170101S	SWITCH	1
254	402071115002S	STUD	1
255	438010010036	SWITCH BOX	1
256	422400140006	MOUNTING BRACKET-LVC	1
257	901051631126S	SCREW	2
258	901030331881	SCREW	1
259	904010101620S	WASHER	1
260	902010101300S	HEX NUT	1
275	901024531123S	SCREW	2
276	438013170154	STARTER	1
277	438010040007S	CLAMP	2
278	438010110054S	INSULATOR SLEEVE	2
279	902012931513S	KEPS NUT	2
280	422400140014	BRACKET	1
282	901030331881	SCREW	1
283	904010101620S	WASHER	1
284	902010101300S	HEX NUT	1