

**10" TILTING ARBOR UNISAW  
RIGHT TILT**  
(For Units with Serial Nos. 97F0000 and Higher)

**CS-4K-14**  
Part No 422-04-651-0040

Revised 4-22-99

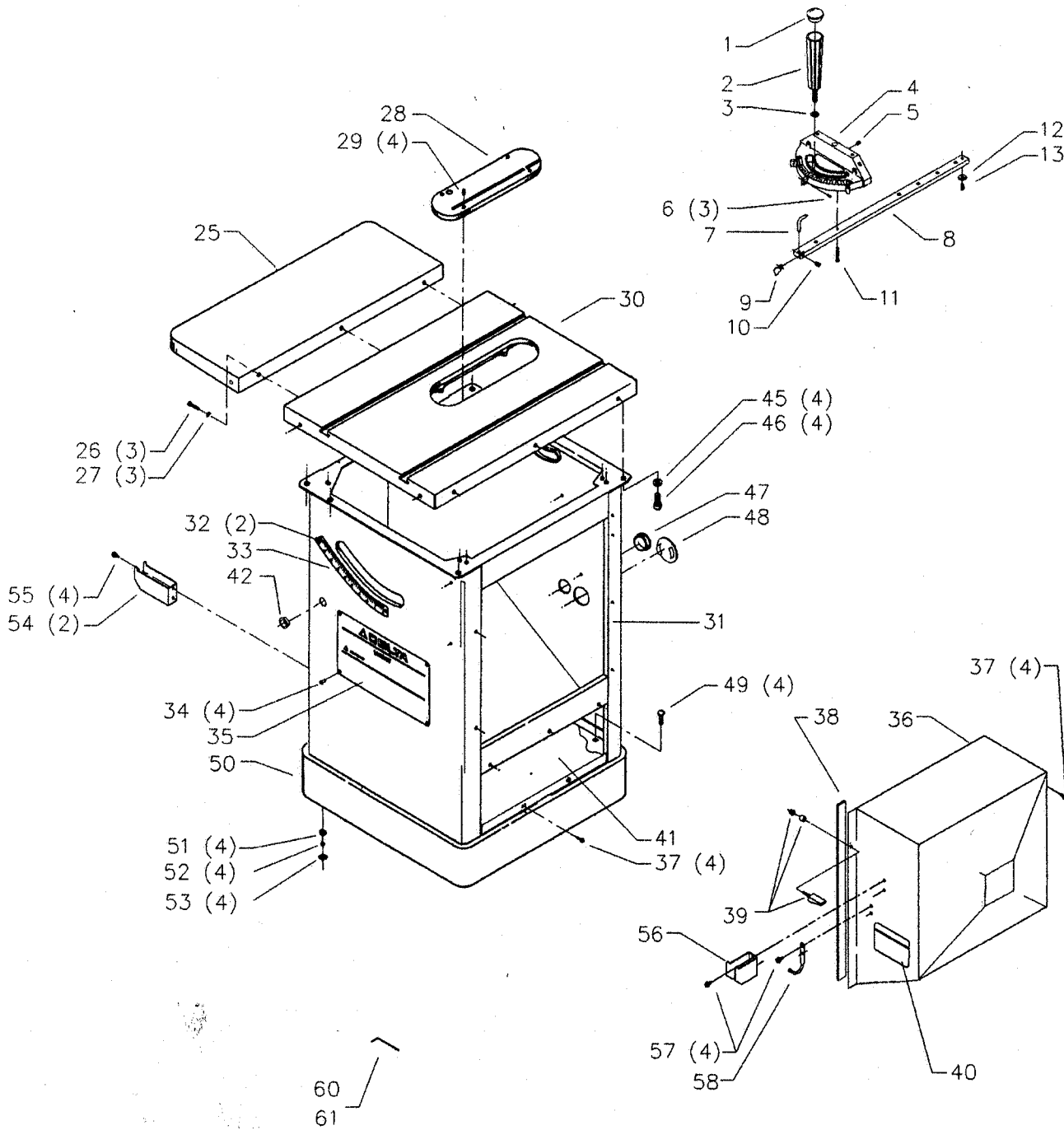

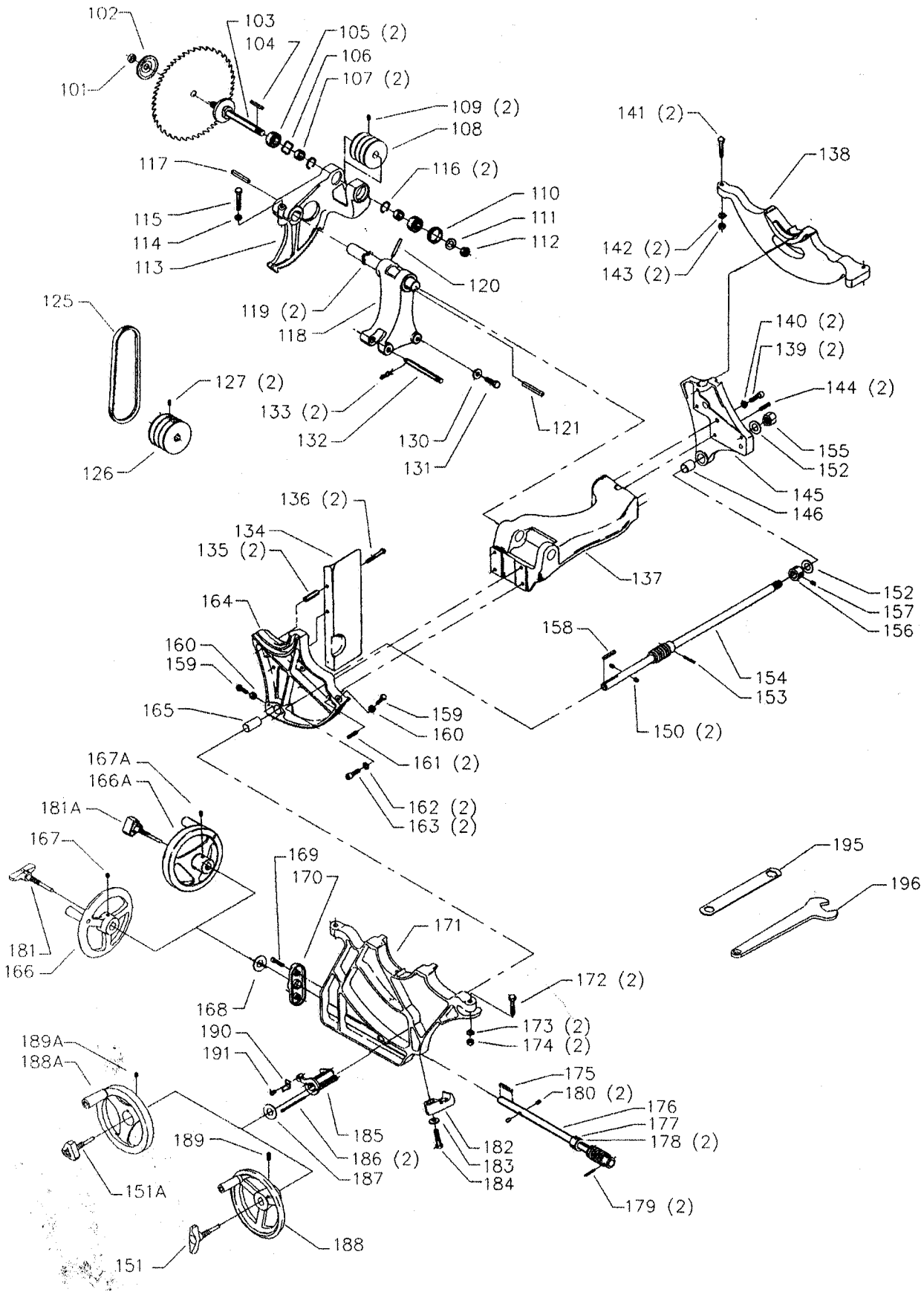

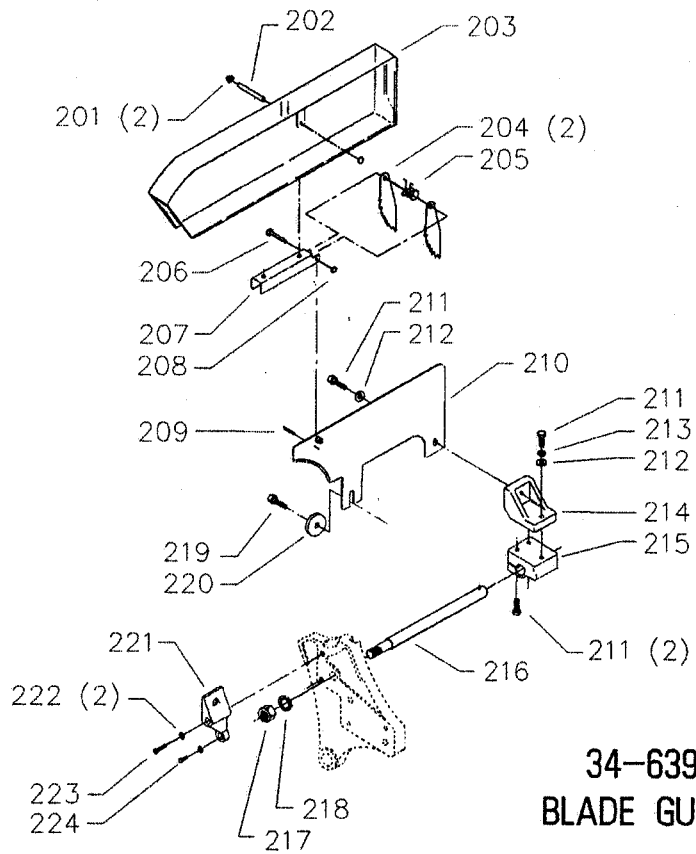

**34-639  
BLADE GUARD**

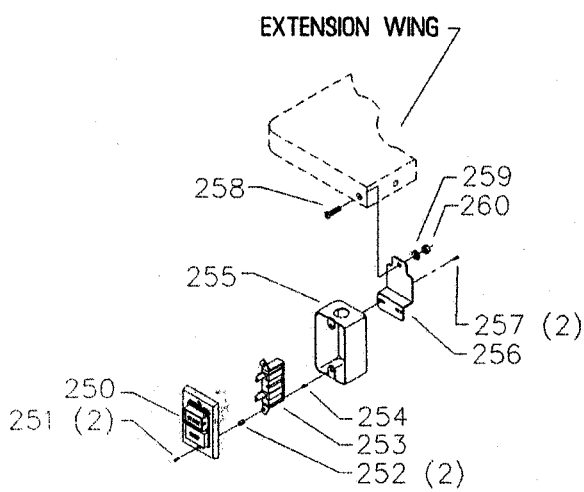

**FOR USE WITH LVC MODELS ONLY**

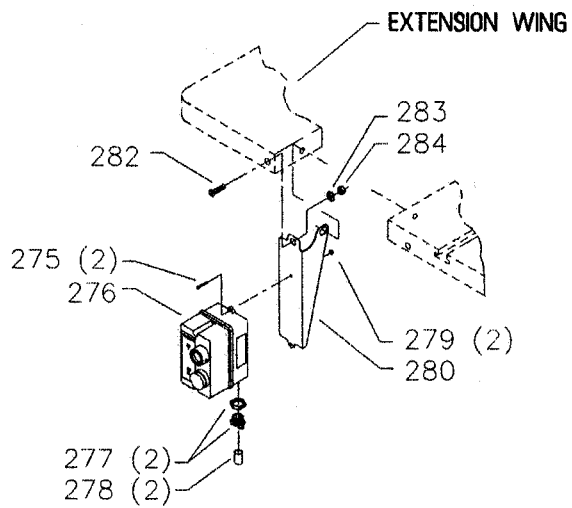

**FOR SPECIAL EDITION  
(GPE) MODELS ONLY**

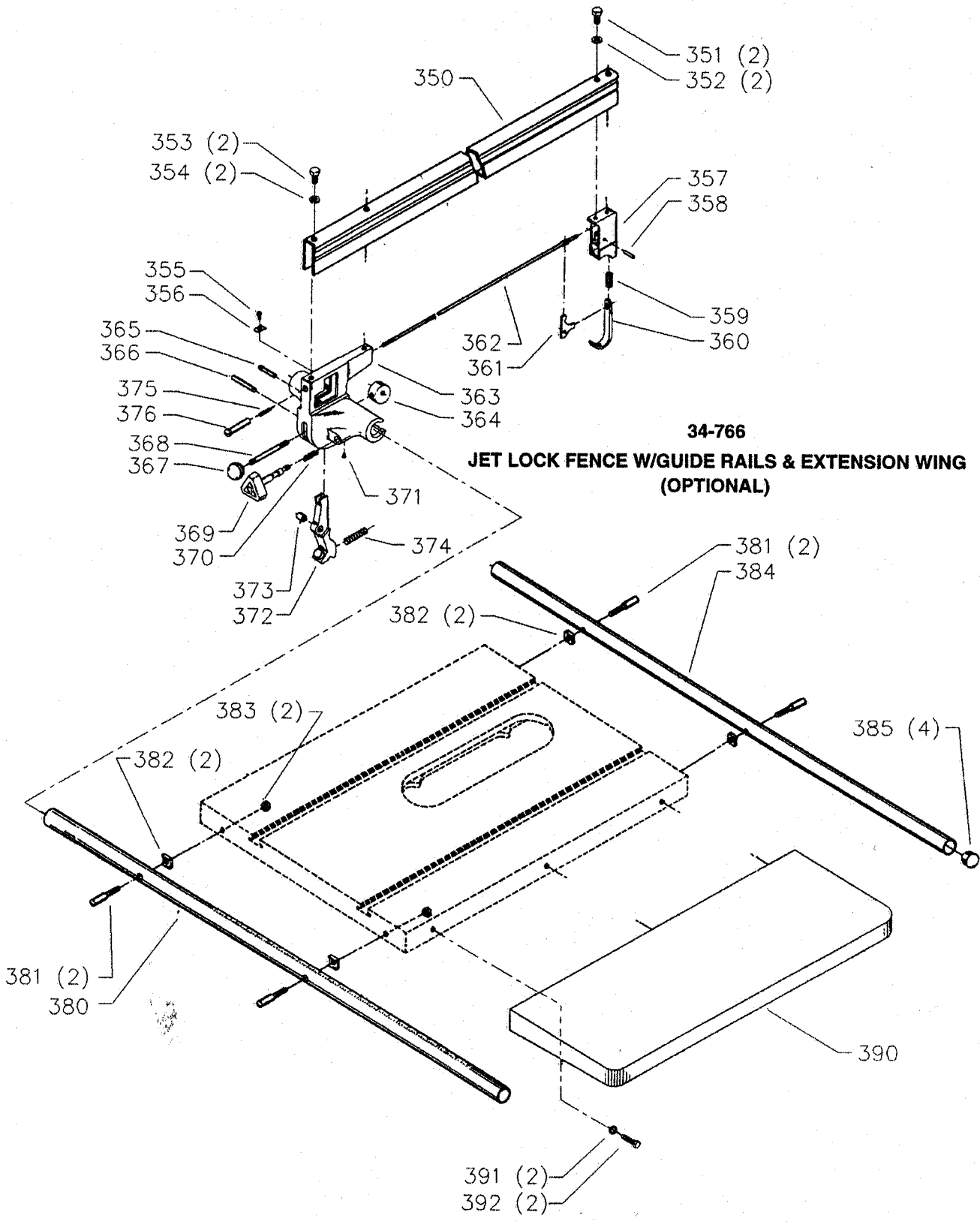

**34-766**  
**JET LOCK FENCE W/GUIDE RAILS & EXTENSION WING**  
**(OPTIONAL)**

## Parts List for 36-920 Type 1

Item Number	Part Number	Description	Qty Required
1	422020740001S	HOLE PLUG	1
2	422020600003S	HANDLE	1
3	904070105555S	FIBRE WSHR	1
4	422013550004	MITER GAGE BODY	1
4	34-895	MITER GAUGE	1
5	901041501181S	SET SCREW	1
6	901041509428S	SET SCREW	3
7	422010750001S	POINTER	1
8	34-895	MITER GAUGE	1
9	422010880004S	STOP LINK	1
10	901041501181S	SET SCREW	1
11	422011120001S	SCREW	1
12	422040720001S	PLATE	1
13	901020305750S	MACHINE SCREW	1
25	000000-00	No Longer Available	1
26	901010609964	SCREW	3
27	904100312097S	SPECIAL WASHER	3
28	34-154	STD INS 10IN CONT SW	1
29	901044615297	SCREW	4
30	422043910003S	TABLE	1
31	422043180003	CABINET ASSY	1
32	1087794	RIVET	2
33	422041320002	TILT SCALE	1
34	1087794	RIVET	4
35	000000-00	No Longer Available	1
36	736828	MOTOR COVER	1
37	901052131498	SCREW	8

## Parts List for 36-920 Type 1

Item Number	Part Number	Description	Qty Required
38	400064160001	GASKET	1
39	537850040001	LATCH W/BUSH & NUT	1
40	422047520187S	WARNING LABEL	1
41	000000-00	No Longer Available	1
42	438010110021	INSULATOR	1
45	904100312097S	SPECIAL WASHER	4
46	901030101487	SCREW	4
47	438010110065	PLUG	1
48	438010110074	HOLE PLUG 2 DIA	1
49	901110200834S	CARRIAGE BOLT	4
50	422043050001	SUB BASE	1
51	904010101620S	WASHER	4
52	904020101703S	LOCK WASHER	4
53	902020401303S	SQUARE NUT	4
54	422350140002S	RIP FENCE HOLDER	2
55	901052131498	SCREW	4
56	422350140001	MITER GAGE HOLDER	1
57	901052131498	SCREW	4
58	422350600001S	WRENCH HOOK	1
60	955030100001	1/4 HEX WRENCH	1
61	955030102155	5/64 HEX WRENCH	1
101	902012009848S	ARBOR NUT-LH	1
102	422041035001S	FLANGE	1
103	422043030003S	ARBOR & FLANGE	1
104	927030202660S	KEY	1
105	1086894S	BEARING	2
106	928060207382S	LOAD SPRING	1

## Parts List for 36-920 Type 1

Item Number	Part Number	Description	Qty Required
107	422041040002S	SPACER	2
108	422041300003S	ARBOR PULLEY	1
109	A10686	SCREW	2
110	902070207176S	BEARING CLOSURE NUT	1
111	904050106664	LOCKWASHER	1
112	902012009847S	SPECIAL NUT	1
113	422043145002S	ARBOR BRACKET	1
113	422043145003S	ARBOR BRACKET	1
114	904020201704S	LOCK WASHER	1
115	901010603102S	CAP SCREW	1
116	904151017147S	RET RING	2
117	927030102653S	KEY	1
118	422043145004	MOTOR BRACKET	1
119	928060114128S	SPRING WASHER	2
120	905010105072	ROLL PIN	1
121	927030102657S	KEY	1
125	5140043-25	3V-BLTS 4L 261/16	1
126	41-644	HD 3GROOVE PULLY	1
127	A10686	SCREW	2
130	904100312097S	SPECIAL WASHER	1
131	901010600664S	CAP SCREW	1
132	422040715001S	STEEL PIN	1
133	422040795001S	SPRING CLIP	2
134	422040365001	DEFLECTOR	1
135	422041045005	SLEEVE	2
136	901010600613	MACHINE SCREW	2
137	422041025002	YOKE	1

## Parts List for 36-920 Type 1

Item Number	Part Number	Description	Qty Required
138	422040140051S	TRUNNION BRACKET	1
139	901030100775S	CAP SCREW	2
140	904020201704S	LOCK WASHER	2
141	901010600682	CAP SCREW	2
142	904020201704S	LOCK WASHER	2
143	902010101207	HEX NUT	2
144	905010102734	ROLL PIN	2
145	422043955002	REAR TRUNNION	1
146	920750113934	BEARING	1
150	422040740001S	PLUG	2
151	422044120009S	LOCK KNOB	1
151	422044120009S	LOCK KNOB	1
152	904010213577S	FIBER WASHER	1
153	905010102706S	ROLL PIN	1
154	422044065002	RAISING SHAFT	1
154	A09527S	SS/A-ELEV SHAFT/GEAR	1
155	902012101036S	HEX NUT	1
156	434014040001	COLLAR W SCRW	1
157	901041500206	SET SCREW	1
158	927030102650S	KEY	1
159	SSF-616-ZN	SCREW .313-24X1.00 H	1
160	902010201228	HEX JAM NUT	1
161	905010102734	ROLL PIN	2
162	904020201704S	LOCK WASHER	2
163	901030100775S	CAP SCREW	2
164	422043955001	FRONT TRUNNION	1
165	920750113935S	BUSHING	1



## Parts List for 36-920 Type 1

Item Number	Part Number	Description	Qty Required
166	422044000005S	HANDWHEEL	1
166	422044000005S	HANDWHEEL	1
167	901041500206	SET SCREW	1
167	901041500206	SET SCREW	1
168	904070105569	FIBRE WASHER	1
169	901030100750	CAP SCREW	1
170	422040310015	COVER PLATE	1
171	422040145001	FRONT BRACKET	1
172	901010600682	CAP SCREW	2
173	904020201704S	LOCK WASHER	2
174	902010101207	HEX NUT	2
175	927030102650S	KEY	1
176	422044065001S	TILT SHAFT W/WORM	1
177	904100314509S	COLLAR	1
178	904010213577S	FIBER WASHER	2
179	905010102706S	ROLL PIN	2
180	422040740001S	PLUG	2
181	422044120009S	LOCK KNOB	1
181	422044120009S	LOCK KNOB	1
182	422040550006	GUIDE BLOCK	1
183	904100312097S	SPECIAL WASHER	1
184	901010600681	CAP SCREW	1
185	422040142008S	POINTER BRACKET	1
186	919714	SHEET MTL SCR	2
187	904070105569	FIBRE WASHER	1
188	422044000005S	HANDWHEEL	1
188	422044000005S	HANDWHEEL	1

## Parts List for 36-920 Type 1

Item Number	Part Number	Description	Qty Required
189	901041500206	SET SCREW	1
189	901041500206	SET SCREW	1
190	422040750002	POINTER	1
191	901061103036	SELF-TAP SCREW	1
192	438010040054	CABLE TIE	1
195	422391010001S	BOX-END WRENCH	1
196	955010501472	OPEN-END WRENCH	1
201	1086935	BLADE GUARD	1
201	1086388S	PUSH NUT CAP	2
201	734639	SEE THRU BL GD	1
202	1087811S	PIN	1
203	1086334S	SEE THRU GUARD	1
204	422160470001S	KICK BACK FINGER	2
205	1086353S	SPRING	1
206	422040710007S	PIN	1
207	1086337S	PIVOT BRACKET	1
208	1086387S	PUSH NUT	1
209	905010106729S	PIN	1
210	422040860002S	SPLITTER W/BUSHING	1
211	901010600649S	CAP SCREW	2
212	904010101620S	WASHER	1
213	904020101703S	LOCK WASHER	1
214	422040140052S	SPLITTER BRACKET	1
215	422040140053S	BRACKET	1
216	422040890003S	SUPPORT ROD	1
217	902010201226S	NUT	1
218	904030201751	LOCK WASHER	1

## Parts List for 36-920 Type 1

Item Number	Part Number	Description	Qty Required
219	901010600649S	CAP SCREW	1
220	422030720001S	PLATE	1
221	422040140037S	SPLITTER BRACKET	1
222	904010312934S	WASHER	2
223	901030100230S	SCREW	1
224	901030100755S	CAP SCREW	1
250	1340100	SWITCH COVER ASSY	1
251	901020100567S	MACHINE SCREW	2
252	402071045007S	SPACER	2
253	438010170101S	SWITCH	1
254	402071115002S	STUD	1
255	438010010036	SWITCH BOX	1
256	422400140006	MOUNTING BRACKET-LVC	1
257	901051631126S	SCREW	2
258	901030331046S	FLAT HEAD SCREW	1
259	904010101620S	WASHER	1
260	902010101300S	HEX NUT	1
275	901024531123S	SCREW	2
276	438013170154	STARTER	1
277	438010040007S	CLAMP	2
278	438010110054S	INSULATOR SLEEVE	2
279	902012931513S	KEPS NUT	2
280	422400140014	BRACKET	1
282	901030331046S	FLAT HEAD SCREW	1
283	904010101620S	WASHER	1
284	902010101300S	HEX NUT	1
350	000000-00	No Longer Available	1

## Parts List for 36-920 Type 1

Item Number	Part Number	Description	Qty Required
350	000000-00	No Longer Available	1
350	422190430001	FENCE BODY	1
351	901010600605	CAP SCREW	2
352	904010101620S	WASHER	2
353	901010600677	CAP SCREW	2
354	904010331451	WASHER	2
355	491948-00	SCREW	1
356	951010207849	POINTER	1
357	422040105002	REAR SLIDE BLOCK	1
358	905040714459	STEEL PIN	1
359	928010414118	COIL SPRING	1
360	422040270001	HOOK	1
361	422040675001	LEVER	1
362	422041085001	ROD	1
363	422040125005	FRONT CLAMP BODY	1
363	422043125008	FRONT CLAMP	1
364	000000-00	No Longer Available	1
365	422040715005	PIN	1
366	422040715004	PIN	1
367	931010114091	BALL HANDLE	1
368	422041115002	LEVER	1
369	422043515002S	KNOB & PINION	1
370	928012015898	SPRING	1
371	901041606218	SCREW	1
372	422043275002	FRONT CLAMP SHOE	1
373	904080214550	RUBBER BUSHING	1
374	928010414123S	SPRING	1

## Parts List for 36-920 Type 1

Item Number	Part Number	Description	Qty Required
375	928010215301	SPRING	1
376	422041055001	SLEEVE	1
380	000000-00	No Longer Available	1
380	422040550001	FRONT GUIDE RAIL	1
381	422041125007	SPECIAL SCREW	4
382	422041040001	SPACER	4
383	902010101207	HEX NUT	2
384	422040550002	REAR GUIDE RAIL	1
385	961010107462	END PLUG	4
390	000000-00	No Longer Available	1
391	904010101638	STEEL WASHER	2
392	901010609964	SCREW	2
856	000000-00	No Longer Available	1
856	000000-00	No Longer Available	1
856	000000-00	No Longer Available	1