

Tool #	Model
4R0001N	Contact Actuation
4R2001N	Contact Actuation

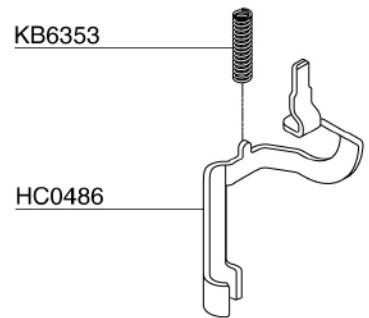

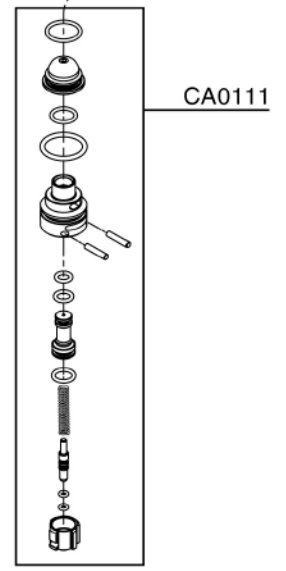
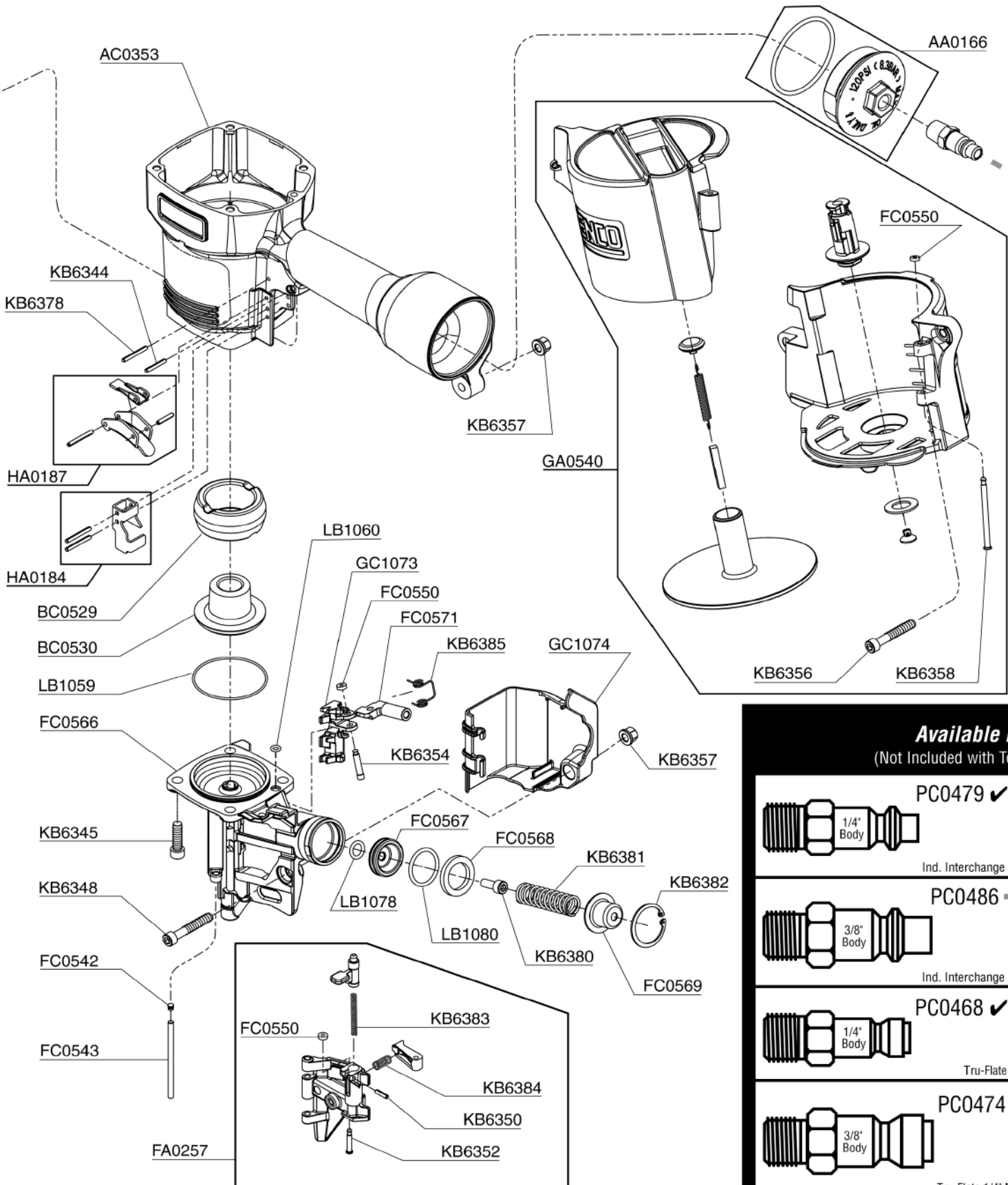

NFG04R Revised July 29, 2008 (Replaces 6/27/08) © 2007, 2008 by Senco Products, Inc. Cincinnati, Ohio 45244 - U.S.A.

Available Plugs

(Not Included with Tool)

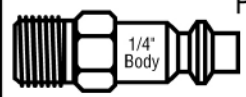
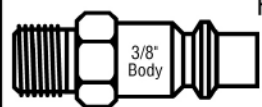
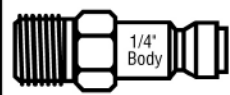
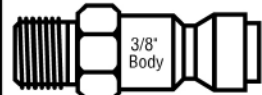
	PC0479 ✓
	1/4" Body
	Ind. Interchange 1/4"
	PC0486
	3/8" Body
	Ind. Interchange 1/4"
	PC0468 ✓
	1/4" Body
	Tru-Flate 1/4"
	PC0474
	3/8" Body
	Tru-Flate 1/4" NPT

✓ Recommended Plugs
Plugs shown smaller than actual size

PART NO.	DESCRIPTION	DESCRIPCIÓN	BESCHREIBUNG	DÉSIGNATION
AA0166	CAP	TAPA	KAPPE	BOUCHON
AC0351	COVER	PLACA	SCHUTZPLATTE	BOUCLIER ANTIABRASIF
AC0352	SEAL, CYLINDER CAP	SELLO	DICHTUNG	JOINT
AC0353	MAIN BODY	CARCASA	GEHAUSE	CORPS
AC0361	CAP	TAPA	KAPPE	BOUCHON
BC0522	RETAINER	JUNTA TÓRICA	SICHERUNGSRING	RETENUE
BC0524	WASHER	ARANDELA	SCHIBE	RONDELLE
BC0526	CYLINDER COLLAR	CILINDRO	ZYLINDER	CYLINDRE
BC0528	SPACER, CYLINDER	SEPARADOR	DISTANZSTÜCK	ENRETOISE
BC0529	STOP, PISTON	TOPPE	PUFFER	ARRÊT
BC0530	STOP, PISTON	TOPPE	PUFFER	ARRÊT
BC0531	SEAL	SELLO	DICHTUNG	JOINT
BC0532	SEAL	SELLO	DICHTUNG	JOINT
BC0533	DEFLECTOR	DESVIADOR	ABWEISER	DEFLECTEUR
BC0534	MUFFLER	SILENCIADOR	DAMPFER	SILENCIEUX
BC0545	SEAL	SELLO	DICHTUNG	JOINT
BC0546	VALVE	VALVULA	VENTIL	VALVE
BC0547	CYLINDER	CILINDRO	ZYLINDER	CYLINDRE
CA0111	VALVE ASSEMBLY	ASAMBLE DE VALVULA	VENTIL-ZUSAMMENBAU	VALVE D'ASSEMBLÉE
EA0172	DRIVER ASSY	PERCUSOR	TREIBER	COUPEAU
FA0257	LATCH ASY	ASAMBLE DE UNETA	VERSCHLUSS-ZUSAMMENBAU	DOIGHT DE RETUNUE
FC0542	RETAINER	JUNTA TÓRICA	SICHERUNGSRING	RETENUE
FC0543	PIN	PASADOR	STIFT	GOUPILLE
FC0550	RETAINER	JUNTA TÓRICA	SICHERUNGSRING	RETENUE
FC0566	GUIDE BODY	PLACA DE NARIZ	NAGELFUHRUNG	FRONT
FC0567	PISTON, FEED	PISTON	KOLBEN	PISTON
FC0568	STOP	TOPPE	PUFFER	ARRÊT
FC0569	CAP	TAPA	KAPPE	BOUCHON
FC0571	PISTON, FEED	PISTON	KOLBEN	PISTON
GA0540	MAGAZINE	CARGADOR	MAGAZIN	MAGASIN
GC1073	FEED PAWL	ALIMENTADOR	VORSCHIEBER	POUSSOIR
GC1074	COVER	CUBIERTA	ABDECKUNG	COVERCLE
HA0184	SAFETY ELEMENT ASSEMBLY	ASAMBLE DE SEGURO	SICHERHEITSVORRICHTUNG-ZUSAMMENBAU	ENSEMBLE PALPEUR DE SÉCURITÉ
HA0187	TRIGGER ASSEMBLY	ASAMBLE DE GATILLO	AUSLÖSER-ZUSAMMENBAU	GÂCHETTE D'ASSEMBLÉE
HC0486	SAFETY ELEMENT	SEGURO	SICHERHEITSVORRICHTUNG	PALPEUR DE SÉCURITÉ
KB6342	SCREW	TORNILLO	SCHRAUBE	VIS
KB6343	SPRING	RESORTE	FEDER	RESSORT
KB6344	PIN	PASADOR	STIFT	GOUPILLE
KB6345	SCREW	TORNILLO	SCHRAUBE	VIS
KB6348	SCREW	TORNILLO	SCHRAUBE	VIS
KB6350	PIN	PASADOR	STIFT	GOUPILLE
KB6352	PIN	PASADOR	STIFT	GOUPILLE
KB6353	SPRING	RESORTE	FEDER	RESSORT
KB6354	PIN	PASADOR	STIFT	GOUPILLE
KB6356	SCREW	TORNILLO	SCHRAUBE	VIS
KB6357	NUT	TUERCA	MUTTE	ECROU
KB6358	PIN	PASADOR	STIFT	GOUPILLE
KB6359	SCREW	TORNILLO	SCHRAUBE	VIS
KB6378	PIN	PASADOR	STIFT	GOUPILLE
KB6379	SCREW	TORNILLO	SCHRAUBE	VIS
KB6380	SCREW	TORNILLO	SCHRAUBE	VIS
KB6381	SPRING	RESORTE	FEDER	RESSORT
KB6382	RING	ANILLO	REIFEN	ANNEAU
KB6383	SPRING	RESORTE	FEDER	RESSORT
KB6384	SPRING	RESORTE	FEDER	RESSORT
KB6385	SPRING	RESORTE	FEDER	RESSORT
LB1045	SEAL	SELLO	DICHTUNG	JOINT
LB1046	SEAL	SELLO	DICHTUNG	JOINT
LB1047	SEAL	SELLO	DICHTUNG	JOINT
LB1048	SEAL	SELLO	DICHTUNG	JOINT
LB1049	SEAL	SELLO	DICHTUNG	JOINT
LB1050	SEAL	SELLO	DICHTUNG	JOINT
LB1059	SEAL	SELLO	DICHTUNG	JOINT
LB1060	SEAL	SELLO	DICHTUNG	JOINT
LB1078	SEAL	SELLO	DICHTUNG	JOINT
LB1079	SEAL	SELLO	DICHTUNG	JOINT
LB1080	SEAL	SELLO	DICHTUNG	JOINT