

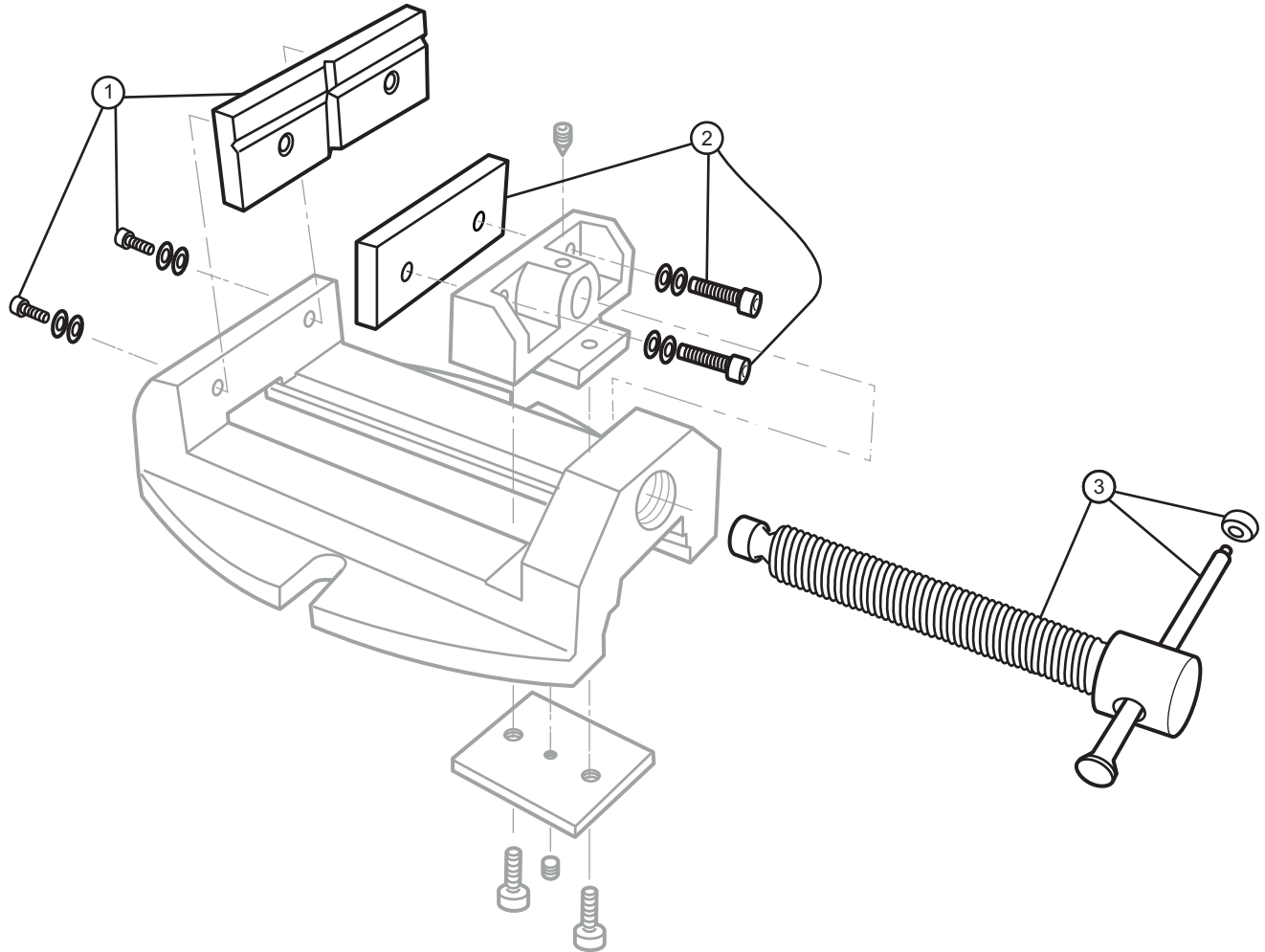

**Versatile Drill Press - Continuous Nut Parts Diagram**  
3" Jaw Width, 2-1/2" Jaw Opening, 1-3/16" Jaw Depth  
Stock #: 63238 Model #: 1335



#	Part	Description
1	63238-01	Fixed Jaw Insert
2	63238-02	Movable Jaw Insert
3	63238-03	Clamp Screw