

Bauart:
Best.-Nr.:

MSfo 869-1c (200Hz,72V)
78206300120



Pos.	Best.-Nr.	Benennung	Stk	Preis UVP o. MwSt. (USD)	AT
0010	31903141002	Motor housing	1	a. A.	-
0020	51819004360	Stator	1	a. A.	-
0030	31419034005	Ring	2	a. A.	-
0040	30517009003	Sleeve	1	a. A.	-
0050	43033008058	Cylinder head screw M5X10	2	a. A.	-
0060	31415032009	Plug	1	a. A.	-
0070	42443004057	Circlip M5	2	a. A.	-
0090	33508046020	Rotor	1	a. A.	-
0170	31206079008	Gearbox housing	1	a. A.	-
0180	41701218024	Grooved ball bearing	1	a. A.	-
0190	32411062009	Disc	1	a. A.	-
0200	30601074004	Felt ring	1	a. A.	-
0210	32416067000	Flange	1	a. A.	-
0220	43050002049	Cylinder head screw M4X12	3	a. A.	-
0230	32612103000	Sealing ring	1	a. A.	-
0250	32624029026	Disc 29X0,1	1	a. A.	-
0250	32624029032	Disc 29X0,3	1	a. A.	-
0265	33809083010	Bevel gear	1	a. A.	-
0270	40221017004	Feather key	1	a. A.	-
0280	42404016081	Disc	1	a. A.	-
0290	42019001088	Nut	1	a. A.	-
0300	32419144010	Bearing plate	1	a. A.	-
0310	32411062009	Disc	1	a. A.	-
0320	30601049000	Felt ring	1	a. A.	-
0330	42639008005	Sealing ring	1	a. A.	-
0340	41701224024	Grooved ball bearing	1	a. A.	-
0350	32416058009	Plate	1	a. A.	-
0360	43050002049	Cylinder head screw M4X12	3	a. A.	-
0370	33406138007	Shaft	1	a. A.	-
0380	40223026004	Feather key	1	a. A.	-
0400	42641001002	Circlip	1	a. A.	-
0410	41706002002	Needle bearing	1	a. A.	-
0420	42616020004	Circlip	1	a. A.	-
0430	32624055024	Disc 55X0,1	1	a. A.	-
0430	32624055030	Disc 55X0,3	1	a. A.	-
0440	40612002009	Sealing ring	1	a. A.	-
0450	40611001002	Sealing ring	4	a. A.	-
0460	43033012056	Cylinder head screw M5X20	4	a. A.	-
0480	40612007002	Sealing ring	1	a. A.	-
0500	32602063006	Air guide ring	1	a. A.	-
0510	30517010005	Sleeve	1	a. A.	-
0520	41701010026	Grooved ball bearing	1	a. A.	-
0530	30905035002	Cup spring	2	a. A.	-
0540	43035022053	Cylinder head screw M5X50	4	a. A.	-
0550	43035020051	Cylinder head screw M5X35	4	a. A.	-
0560	42443004057	Circlip M5	8	a. A.	-
0570	43003029048	Flat headed screw M4X6	1	a. A.	-
0571	42439013046	Lock washer	1	a. A.	-
0572	42404005048	Disc	1	a. A.	-

Bauart: MSfo 869-1c (200Hz,72V)
Best.-Nr.: 78206300120



Pos.	Best.-Nr.	Benennung	Stk	Preis UVP o. MwSt. (USD)	AT
0580	31408056000	Insulation board	1	a. A.	-
0590	31406033009	Insulating ring	1	a. A.	-
0920	31204179010	Handle half shell	1	a. A.	-
0930	30701286010	Switch	1	a. A.	-
0940	43041035047	Fillister head screw	2	a. A.	-
0950	31324121000	Seal	1	a. A.	-
0960	31324122000	Cable clamping piece	1	a. A.	-
0970	43070035002	Screw	1	a. A.	-
0980	31324123000	Housing	1	a. A.	-
0990	31412063000	Terminal	2	a. A.	-
1000	30719640010	Connecting cable	1	a. A.	-
1010	30605042008	Plate	1	a. A.	-
1020	30706336010	Cable	1	a. A.	-
1030	31413095001	Cable grommet	1	a. A.	-
1040	31204180000	Handle half shell	1	a. A.	-
1050	43070031003	Screw	3	a. A.	-
1055	43070038007	Screw	1	a. A.	-
5000	63801120006	Inner flange	1	a. A.	-
5010	63802052000	Threaded flange	1	a. A.	-
5020	32119117015	anti-vibration handle	1	a. A.	-
5030	31810271020	Safety hood	1	a. A.	-
5040	62903011005	Jaw spanner SW17	1	a. A.	-
5060	62910022002	Bidirectional nut spanner	1	a. A.	-
6000	32160003135	Lubricant tube 0,085 kg	1	a. A.	-
9000	34101066060	Operating instructions	1	a. A.	-
9010	34151066000	List of spare parts MSfo869-1 c/d	1	a. A.	-
9020	34130054061	Safety instruction	1	a. A.	-

Bauart:
Best.-Nr.:

MSfo 869-1c (200Hz,72V)
78206300120

7 820 62 - MS fo 869-1c
7 820 63 - MS fo 869-1c
7 820 64 - MS fo 869-1d
7 820 65 - MS fo 869-1d

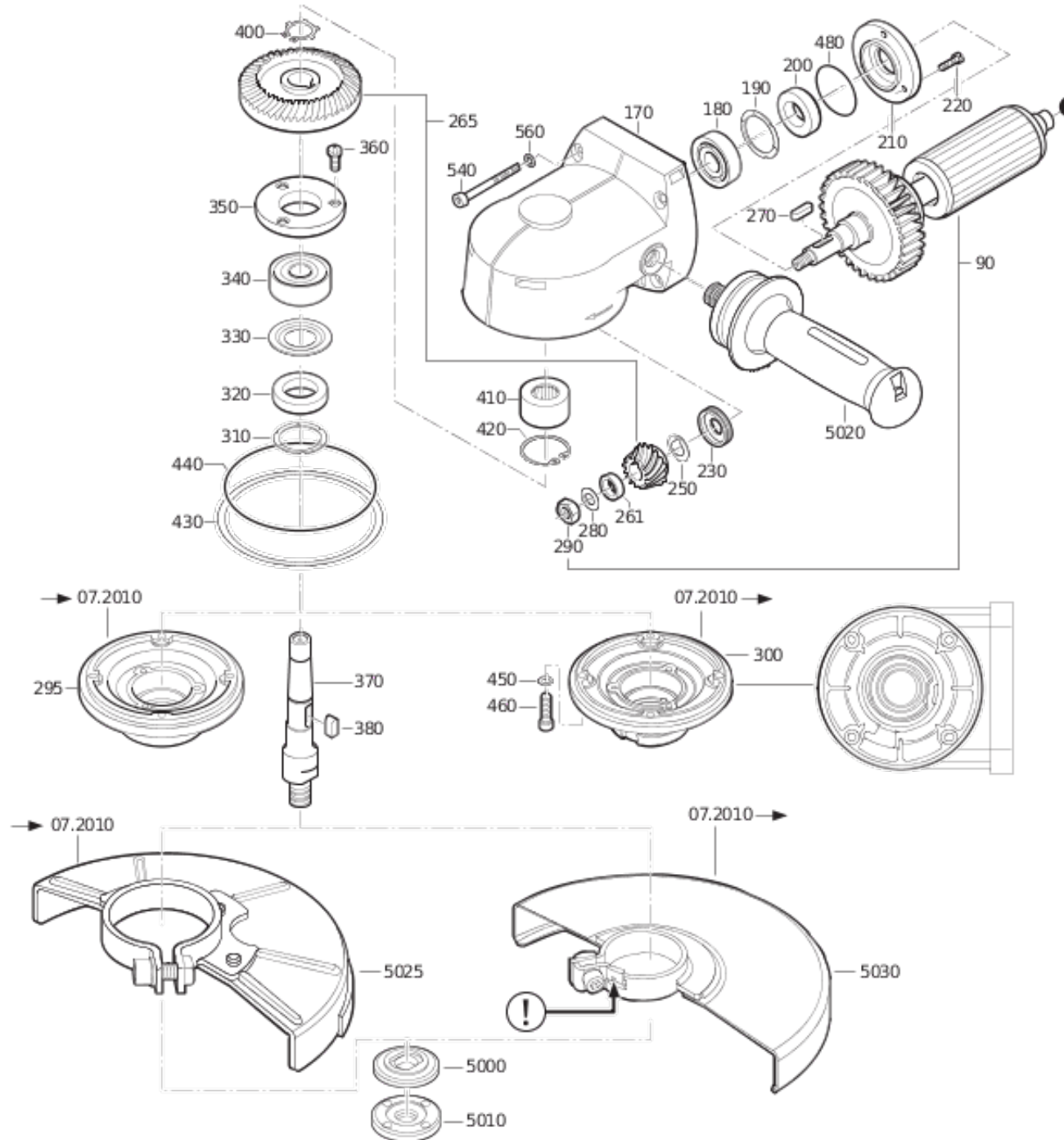

Bauart:
Best.-Nr.:

MSfo 869-1c (200Hz,72V)
78206300120

7 820 62 - MSfo 869-1c
7 820 63 - MSfo 869-1c
7 820 64 - MSfo 869-1d
7 820 65 - MSfo 869-1d

