

The picture shown is for reference only. It may differ from actual unit.

85 Torque 7-10 Ft-Lbs

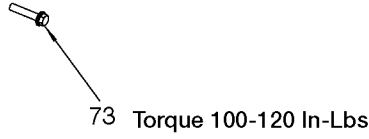
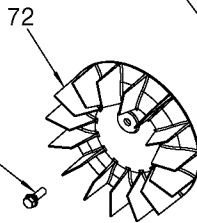
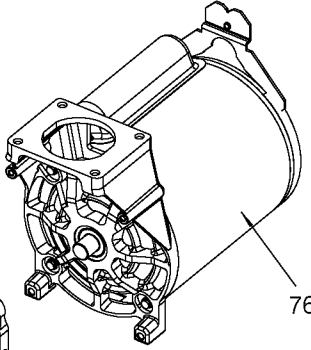
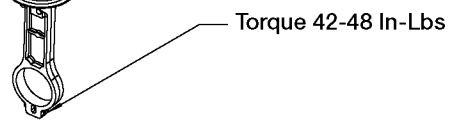
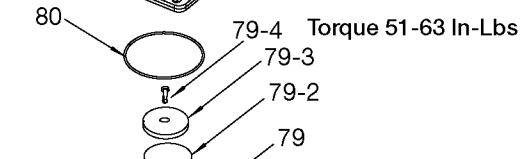
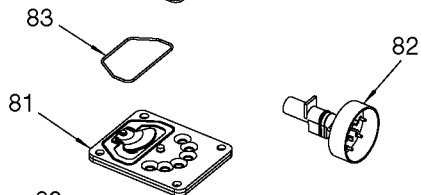
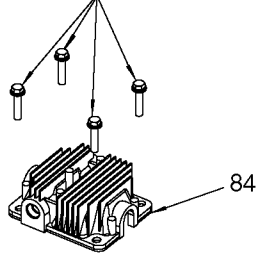

Torque 100-120 In-Lbs

73 Torque 100-120 In-Lbs

Parts List for 919-16871 Type 0

Item Number	Part Number	Description	Qty Required
1	N176201	SHROUD KIT	1
2	D24235	FILTER KIT	1
4	000000-00	No Longer Available	1
5	SSG-3105	ORING 306/296ID 073/	1
6	SSP-7821-1	NUT .563-18 UNF HEX	1
7	AC-0097	TUBE OUTLET .375OD A	1
8	D27685	TUBE PRES REL .250OD	1
9	D20114	VALVE SAFETY 175 .25	1
14	5140118-36	GRIP .875 DIA	1
15	D20155	RING REGULATOR HI-FL	1
16	D26615	CORD POWER ST 14GA 1	1
17	000000-00	No Longer Available	1
18	N176201	SHROUD KIT	1
19	000000-00	No Longer Available	1
20	SSP-7811	ASSY NUT SLEEVE 1/4	2
22	A19712	VALVE CHECK 1/2NPT X	1
23	N176201	SHROUD KIT	1
23	000000-00	No Longer Available	1
24	AC-0774	ISOLATOR 3PT MOUNT 6	3
25	SSP-7813	ASSY NUT SLEEVE 3/8	1
28	ACG-18	CUP SADDLE MOUNT	2
29	91895680	SCREW .250-20X.750 H	2
30	ACG-408	ASSY FASTENER	3
38	LA-3027	LABEL DRAIN TANK ENG	1
39	LA-3069	LABEL CRAFTSMAN	1
51	5140117-89	PRESSURE SWITCH	1
52	D28999	STANDPIPE 1/4 NPT X	1

Parts List for 919-16871 Type 0

Item Number	Part Number	Description	Qty Required
53	SSP-480	NIPPLE 1/4-18 NPT X	1
54	N008792	REGULATOR RPR KIT	1
54	D27256	REGULATOR 4PORT P1P2	1
55	Z-D21923	GAUGE 2 OD 200PSI 1/	1
56	Z-D21924	GAUGE 2 OD 200PSI 1/	1
57	D23957	BODY QC .250 UNIV .2	1
58	D23138	WHEEL 9 BLACK SEMI-P	2
59	CAC-60	BOLT .375-16X2.25 UN	2
60	SSF-8080-ZN	NUT .375-16 UNC-2B H	2
61	SUDL-6-1	STRIP RUBBER FOOT	1
62	N286039	DRAIN VALVE	1
70	SSF-586	SCREW .250-20X.750 U	1
72	AC-0108	FAN 5.75 DIA	1
73	SSF-615	SCREW .250-20X1.25 U	1
74	Z-AC-0140	ASSY ECCENTRIC BEARI	1
76	000000-00	No Longer Available	1
78	KK-4835	KIT CONNECTING ROD L	1
79	KK-4835	KIT CONNECTING ROD L	1
79	KK-4835	KIT CONNECTING ROD L	1
79	ACG-29	CAP CONNECTING ROD C	1
79	SSF-3158-1	SCREW #10-24X.750 TH	1
80	SSG-8156	ORING 2.759/2.719ID	1
81	Z-AC-0032	ASSY VALVE PLATE	1
82	CAC-1371	MUFFLER SINGLE CYL R	1
83	ACG-45	ORING P/L HEAD	1
84	AC-0037	HEAD 3/8 OUTLET FRON	1
85	SSF-927	SCREW .250-20X1.125	4

Parts List for 919-16871 Type 0

Item Number	Part Number	Description	Qty Required
856	D21477	KIT START CAPACITOR	1
856	D29142	KIT START CAPACITOR	1
856	000000-00	No Longer Available	1
856	K-0650	KIT COMP RING REPLAC	1
856	KK-4835	KIT CONNECTING ROD L	1
856	D23936	KIT START CAP GE	1