

29.07.2015 |

## Angle Grinder - F 012 933 000 - 9330

Item	Part Number	Description	Illustration	Price	Quantity	Price Group
4	2 610 938 753	On-Off Switch		1	-,-	1 -
5	2 610 938 749	Cord		1	-,-	1 -
6	2 610 938 756	Grommet		1	-,-	1 -
10	2 610 938 712	Carbon-Brush Set		1	-,-	1 22
651	1 607 950 052	Pin-Type Face-Wrench		1	-,-	1 15
653	2 602 025 067	Auxiliary Handle M10, Ø32,5x105 MM		1	-,-	1 15
654	2 610 938 704	Flange		1	-,-	1 -
655	2 610 938 705	Flange		1	-,-	1 -
656	2 610 938 706	Protective Cover		1	-,-	1 -

F 012 933 000  
Issue | 06-09-20  
Stand

**Fig./Abb. 1**

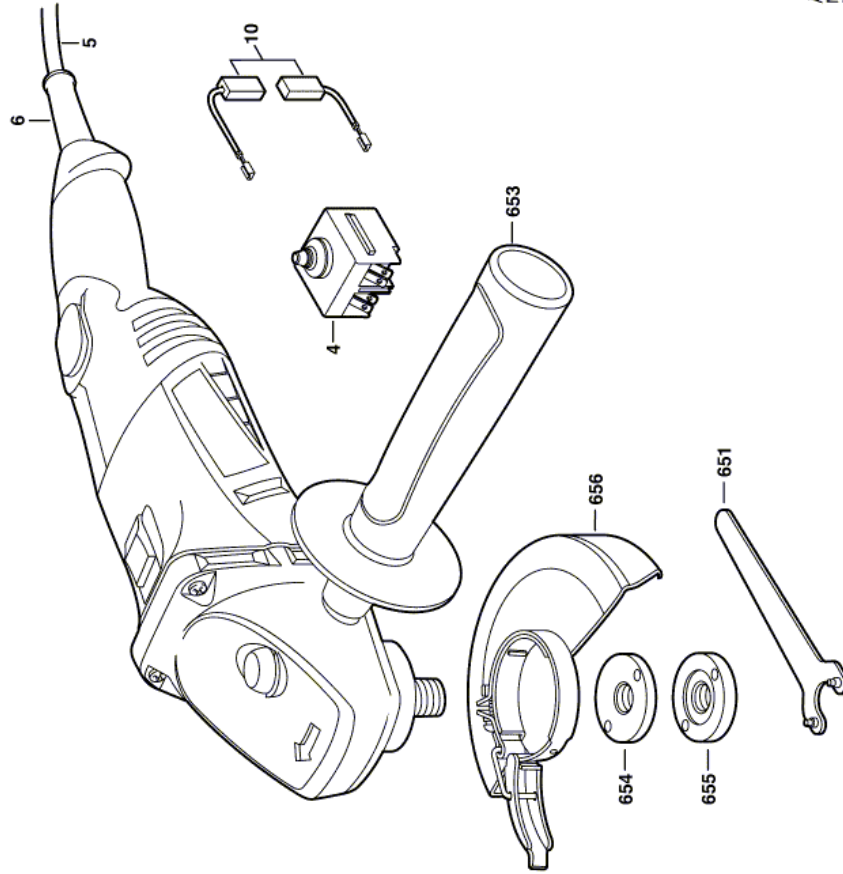

Änderungen vorbehalten  
Modifications reserved  
Modificaciones reservadas  
Salvo modificaciones