

113 Torque to 7-10 ft.-lbs.

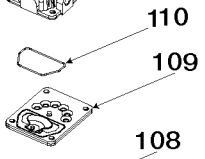

107 Torque to 51-63 in.-lbs.

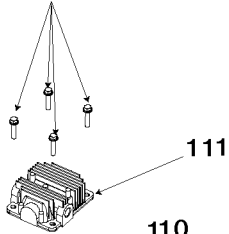
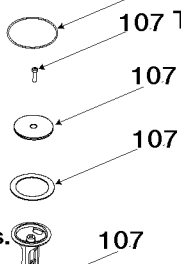

112 Torque to 42-48 in.-lbs.

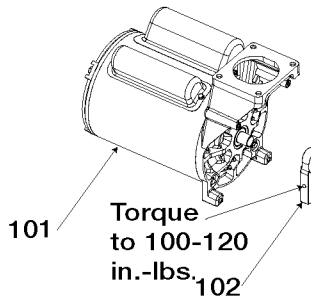
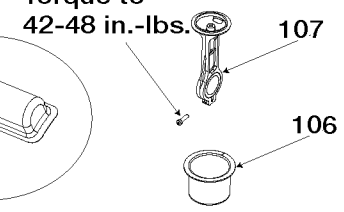
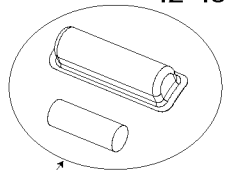

Torque to 100-120 in.-lbs.

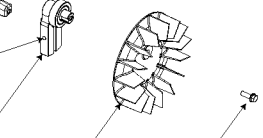

105 Torque to 100-120 in.-lbs.

Parts List for CPF23400S Type 4

Item Number	Part Number	Description	Qty Required
1	000000-00	No Longer Available	1
2	000000-00	No Longer Available	1
3	ACG-19	ISOLATOR 3 POINT MOU	1
4	ACG-18	CUP SADDLE MOUNT	1
5	91895680	SCREW .250-20X.750 H	1
6	D20653	SHROUD MINI P-C GRAY	1
7	ACG-408	ASSY FASTENER	1
8	AC-0261	GRIP HANDLE 1.00 TUB	1
9	A19712	VALVE CHECK 1/2NPT X	1
10	SSP-7813	ASSY NUT SLEEVE 3/8	1
11	SSP-7811	ASSY NUT SLEEVE 1/4	1
12	000000-00	No Longer Available	1
13	A17038	DRAIN VALVE	1
14	D24721	KIT ISOLATOR W/SCREW	1
15	SSG-3105	ORING 306/296ID 073/	1
16	D20694	TUBE OUTLET CPF23400	1
17	SSP-7821-1	NUT .563-18 UNF HEX	1
18	N022307	FILTER ASSY.	1
20	D24888	NIPPLE .25NPT X 2.5	1
21	5140118-56	PRESSURE SWITCH	1
22	TIA-4150	VALVE SAFETY 150 .25	1
23	SSP-6021	BUSHING REDUCER 1/8-	1
24	Z-A07456	GAUGE	1
25	N022053	FILTER REPLACEMENT	1
25	D24322	FILTER REPLACEMENT	1
27	D23299	FITTING 45DG ELBOW B	1
30	D28086	TUBE PRESSURE RELIEF	1

Parts List for CPF23400S Type 4

Item Number	Part Number	Description	Qty Required
31	H-7051	HOSE AIR 1/4 X 10 BL	1
32	D26616	CORD POWER SJOW 14GA	1
33	000000-00	No Longer Available	1
33	D21172	SCREW .250-20X.500 H	1
33	D20155	RING REGULATOR HI-FL	1
33	D23947	PANEL CONSOLE PC RED	1
33	Z-D21924	GAUGE 2 OD 200PSI 1/	1
33	SSP-537	FITTING 90DEG ELBOW	1
33	A13369	ASSY REGULATOR	1
33	N008792	REGULATOR RPR KIT	1
33	A19513	BODY QC .250 IND .25	1
34	CAC-1206-1	CLAMP HOSE .250 ID H	1
101	000000-00	No Longer Available	1
102	Z-AC-0140	ASSY ECCENTRIC BEARI	1
104	AC-0108	FAN 5.75 DIA	1
105	SSF-586	SCREW .250-20X.750 U	1
106	KK-4835	KIT CONNECTING ROD L	1
107	KK-4835	KIT CONNECTING ROD L	1
108	SSG-8156	ORING 2.759/2.719ID	1
109	Z-AC-0032	ASSY VALVE PLATE	1
110	ACG-45	ORING P/L HEAD	1
112	SSF-3158-1	SCREW #10-24X.750 TH	1
113	SSF-927	SCREW .250-20X1.125	1
114	D30144	KIT CAPACITOR	1
856	000000-00	No Longer Available	1
856	000000-00	No Longer Available	1
856	000000-00	No Longer Available	1

Parts List for CPF23400S Type 4

Item Number	Part Number	Description	Qty Required
856	N008806	LABEL HOT SURFACE TR	1
856	LA-3115	LABEL	1
856	KK-4835	KIT CONNECTING ROD L	1
856	K-0650	KIT COMP RING REPLAC	1