

60-70 IN LBS
OF TORQUE
(69-81 CM-KG)
4 PLACES

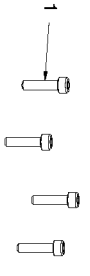

36-45 IN LBS
OF TORQUE
(42-52 CM-KG)

125-140 IN LBS
OF TORQUE
(141-156 CM-KG)
2 PLACES

36-45 IN LBS
OF TORQUE
(42-52 CM-KG)

25-30 IN LBS
OF TORQUE
(28-35 CM-KG)

25-30 IN LBS
OF TORQUE
(28-35 CM-KG)
2 PLACES

60-70 IN LBS
OF TORQUE
(69-81 CM-KG)
3 PLACES

25-30 IN LBS
OF TORQUE
(28-35 CM-KG)

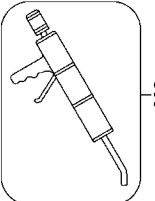
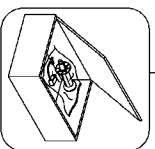
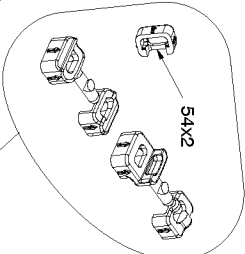
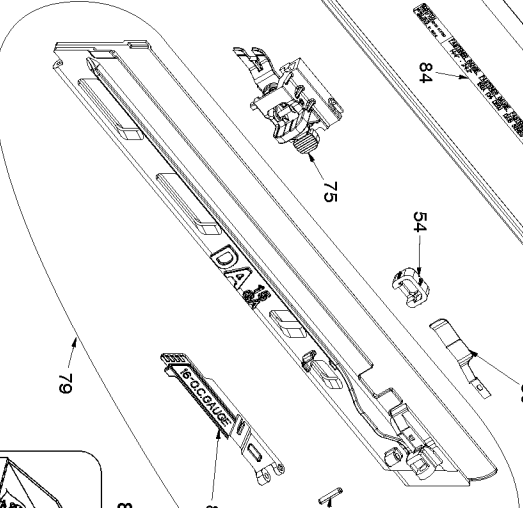
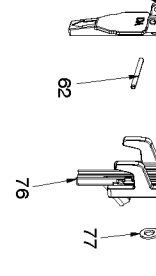
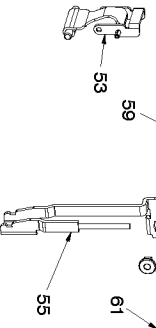
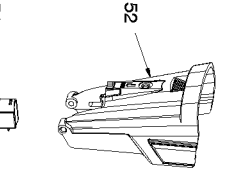

Parts List for DA1564K Type 0

Item Number	Part Number	Description	Qty Required
1	MSC5080-20	SCREW-SOC HD. CAP M5	9
2	9R192032	FRAME CAP ASSEMBLY	1
3	9R192038	SEAL	1
4	9R188810	PLAST RIB FRAME CAP	1
5	9R188852	PLATE-HEAD VALVE	1
6	9R188849	HEAD VALVE SEAL	1
7	9R188859	HEAD/VALVE ASSY.	1
8	9R188846	PISTON RING	1
9	9R192042	PISTON DRIVER ASSY.	1
10	9R192035	CYLINDER	1
11	9R188836	O-RING	2
12	9R188835	CHECK SEAL	1
13	9R188807	BUMPER- LOWER	1
14	9R188847	DRIVER GUIDE	1
15	9R192036	BLOWER TUBE	1
16	166797	O-RING-.056X.060 NBR	2
17	9R192029	FRAME OVERMOLD	1
18	9R192040	AIR FILTER	1
19	9R192039	GASKET	1
20	9R192044	MUFFLER	1
21	9R192034	END CAP	1
23	9R188829	HOUSING HOOK	1
24	9R188830	SEAT PLATE-HOOK	1
25	9R188815	HOOK	1
26	174309	O-RING-1.049X.103	1
27	9R188812	CAP-HOOK	1
28	9R188811	C-RING	1

Parts List for DA1564K Type 0

Item Number	Part Number	Description	Qty Required
29	9R188828	COVER	1
30	TVA15	TRIGGER VALVE	1
31	180476	SPRING-TRIGGER	1
32	180475	PIN-SPRING-M3X20MM	1
33	174345	PIN SPRING	1
34	184507	PIN-MODE SWITCH	1
35	9R188850	MODE SPRING	1
36	184508	BUSHING	1
37	184513	ASSEMBLY-TRIGGER	1
38	184506	BUTTON-MODE SWITCH	1
39	180484	SCREW-SET-M3X8MM	1
40	184519	PIN-TRIGGER LOCK	1
41	MRG002514	O-RING-.098X.055	2
42	9R188822	LOCK BUTTON	1
43	9R188837	SET SCREW	1
44	9R188832	BLOWER SPRING	1
45	9R188823	STEM BLOWER	1
46	9R188768	O-RING	2
47	9R188824	BLOWER BUTTON	1
48	9R188769	SPRING PIN	2
49	MHE5080-100	NUT-NYLON M5X.80	3
50	MSC5080-25	SCREW-SHCS-M5X0.80X2	1
51	9R188861	LIGHT ASSEMBLY	1
52	9R192037	COVER-LOWER CONTACT	1
53	9R188794	ASSEMBLY-PINCH PLATE	1
54	9R188782	CONTACT FOOT-NO MAR	2
55	9R188774	ARM-LOWER CONTACT	1

Parts List for DA1564K Type 0

Item Number	Part Number	Description	Qty Required
56	9R188787	SPRING	1
57	9R192025	TRIP ASSEMBLY	1
58	180311	NUT	1
59	121294	WASHER	1
60	9R188770	SCREW SHCS	1
61	9R192014	DOOR	1
62	180552	PIN-SPRING-M2.5X30MM	1
63	103858	PIN-SPRING-4X20MM	1
64	9R192047	GUIDE- TRIP	1
65	9R192048	ADJUSTING KNOB	1
66	9R188767	CONTACT ARM SPRING	1
67	9R188761	GUIDE-UPPER TRIP	1
68	9R188848	PIN SPRING	1
69	9R188760	ARM- UPPER CONTACT	1
70	MSC6100-30	SCREW-SHCS-M6X1.00X3	2
71	9R192022	PLATE-DRIVER	1
72	9R188831	CONSTANT SPRING	1
73	9R192012	MAGAZINE-UPPER	1
74	9R192015	LINER-NAIL GUIDE	1
75	9R192019	PUSHER ASSEMBLY	1
76	9R192010	NOSE	1
77	180569	WASHER-PLAIN-D5X10X1	3
78	9R188771	SCREW- SOC. HD. CAP	1
79	9R192043	MAGAZINE-LOWER	1
80	9R188801	NAIL STOP	1
81	9R192021	O.C. GAUGE	1
82	9R192046	SPRING PIN	1

Parts List for DA1564K Type 0

Item Number	Part Number	Description	Qty Required
83	120927	LABEL-SENSOR SMALL (1
84	9R192869	LABEL, SPEC(DA1564K)	1
85	180296	LABEL-WARNING	1
86	180582	LABEL-WARNING	1
87	9R188863	TIP PACK	1
800	100679	LUBE (1LB.CAN)	1
800	100653	LUBE (2CC)	1
876	TVA15RF	ACTUATOR ASSY.	1