

CONTENTS:

- 1) Fuel tank, Tubular grip
- 2) Hood, Air filter, Muffler
- 3) Cylinder, Crankcase
- 4) Ignition electronics, Starter
- 5) Oil pump, Clutch
- 6) Chain brake
- 7) Carburetor

1) FUEL TANK, TUBULAR GRIP

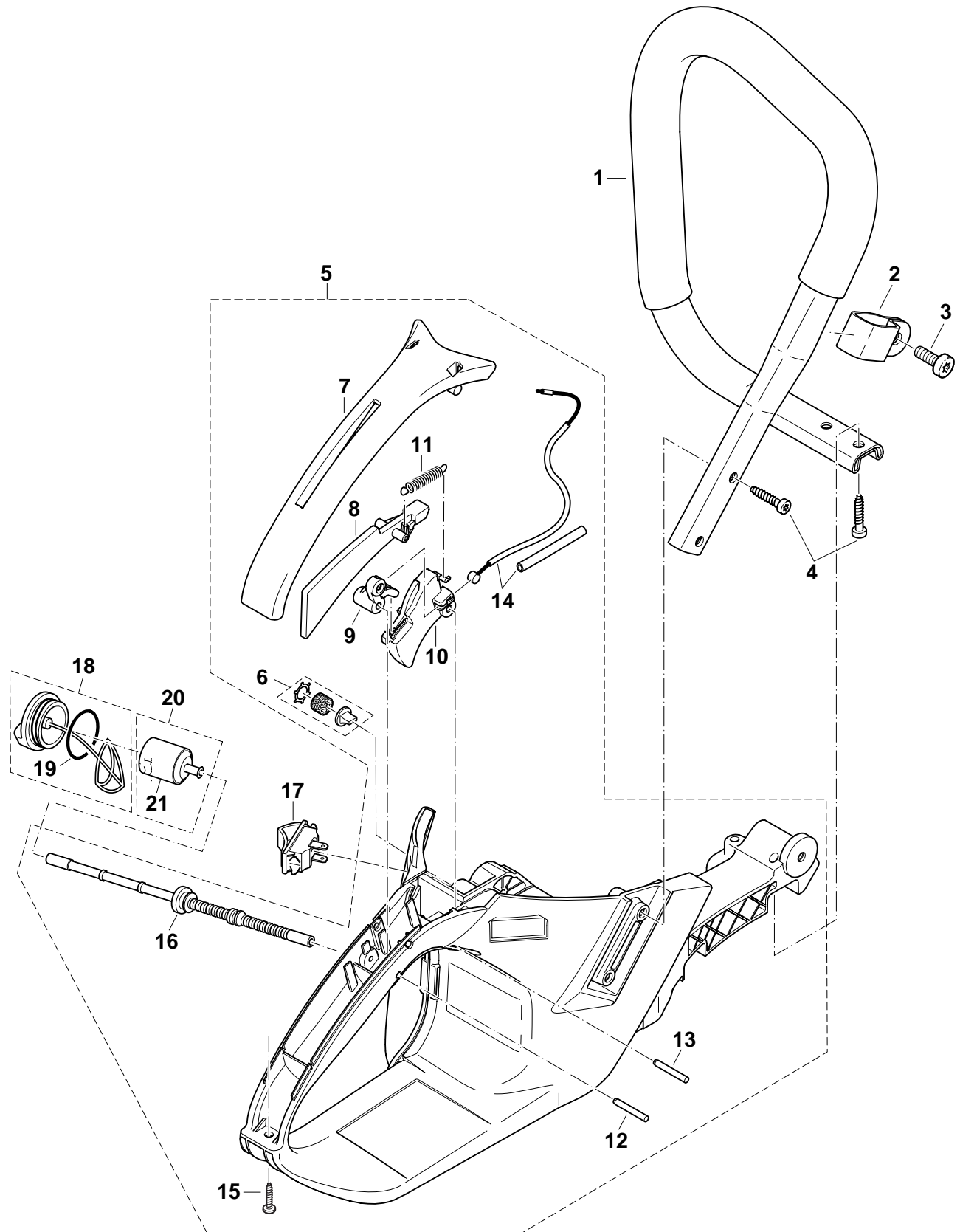

2) HOOD, AIR FILTER, MUFFLER

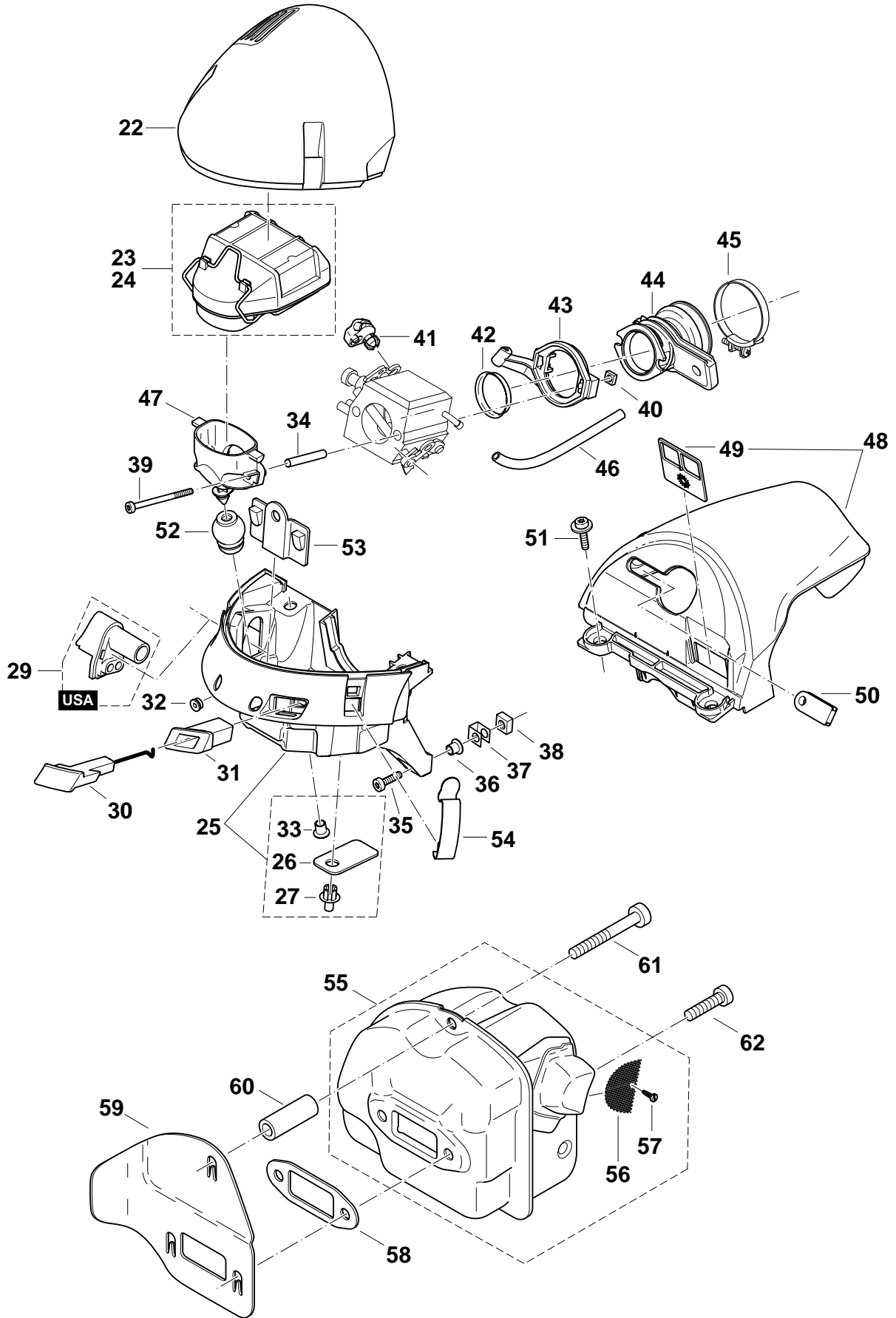

3) CYLINDER, CRANKCASE

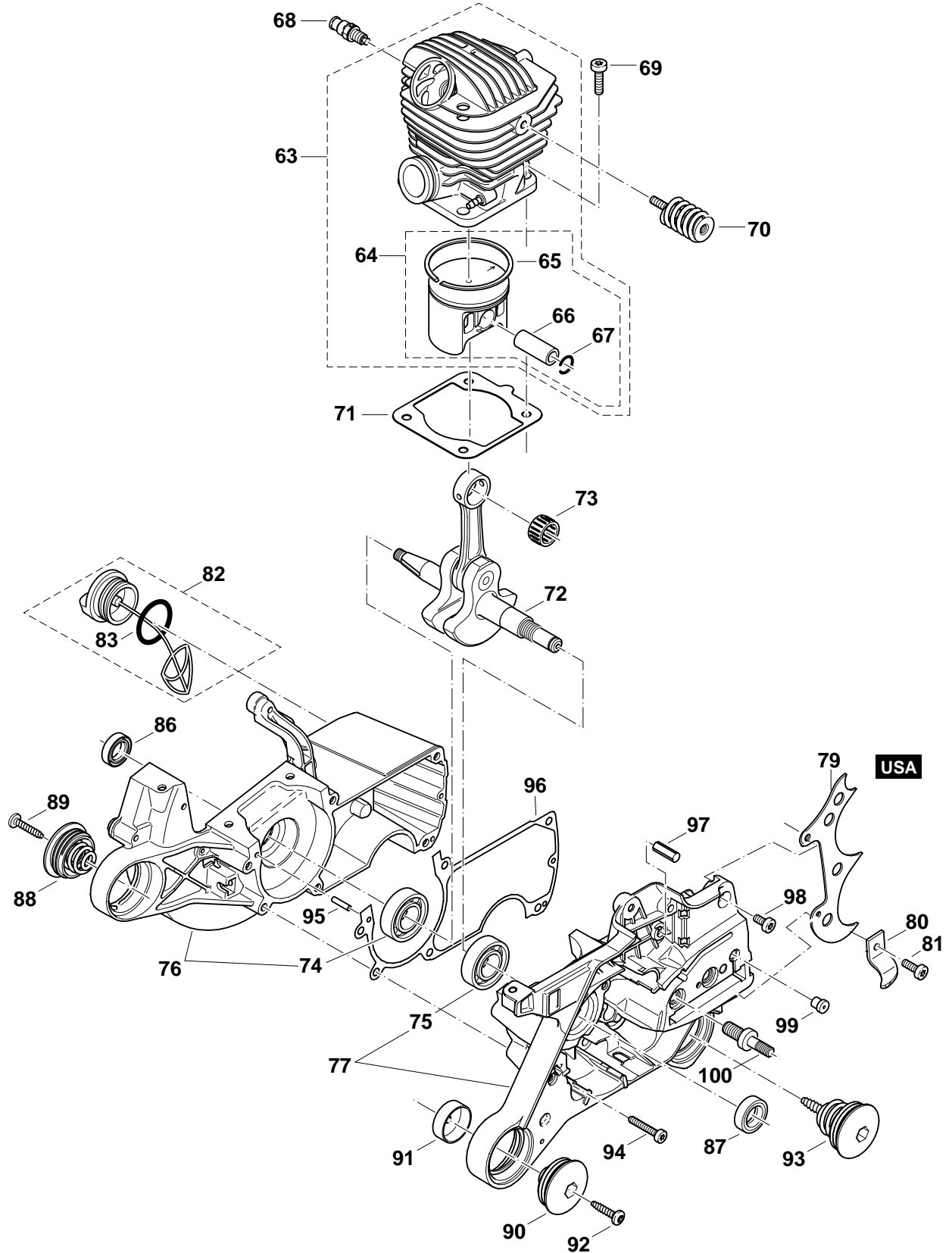

4) IGNITION ELECTRONICS, STARTER

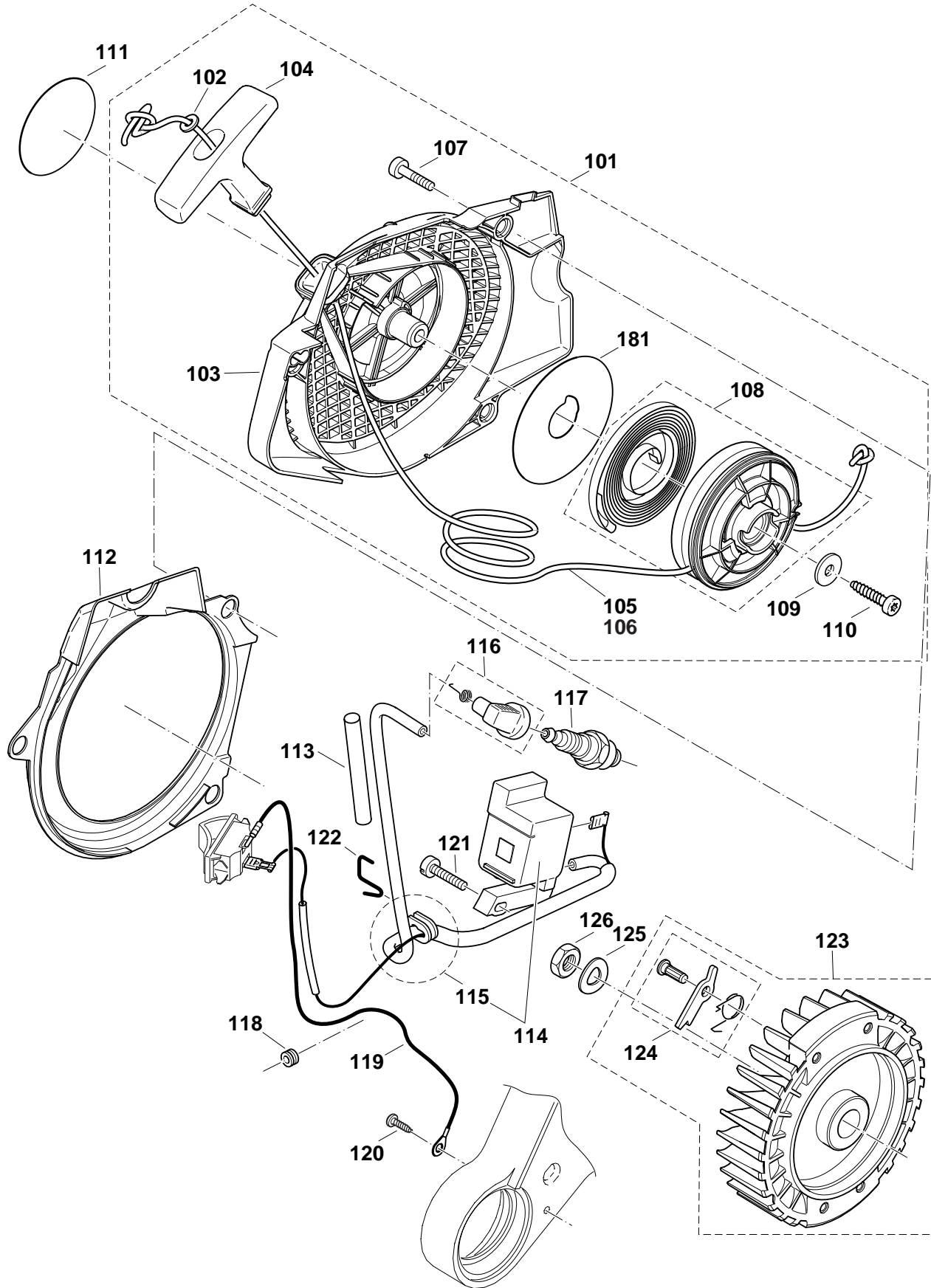

5) OIL PUMP, CLUTCH

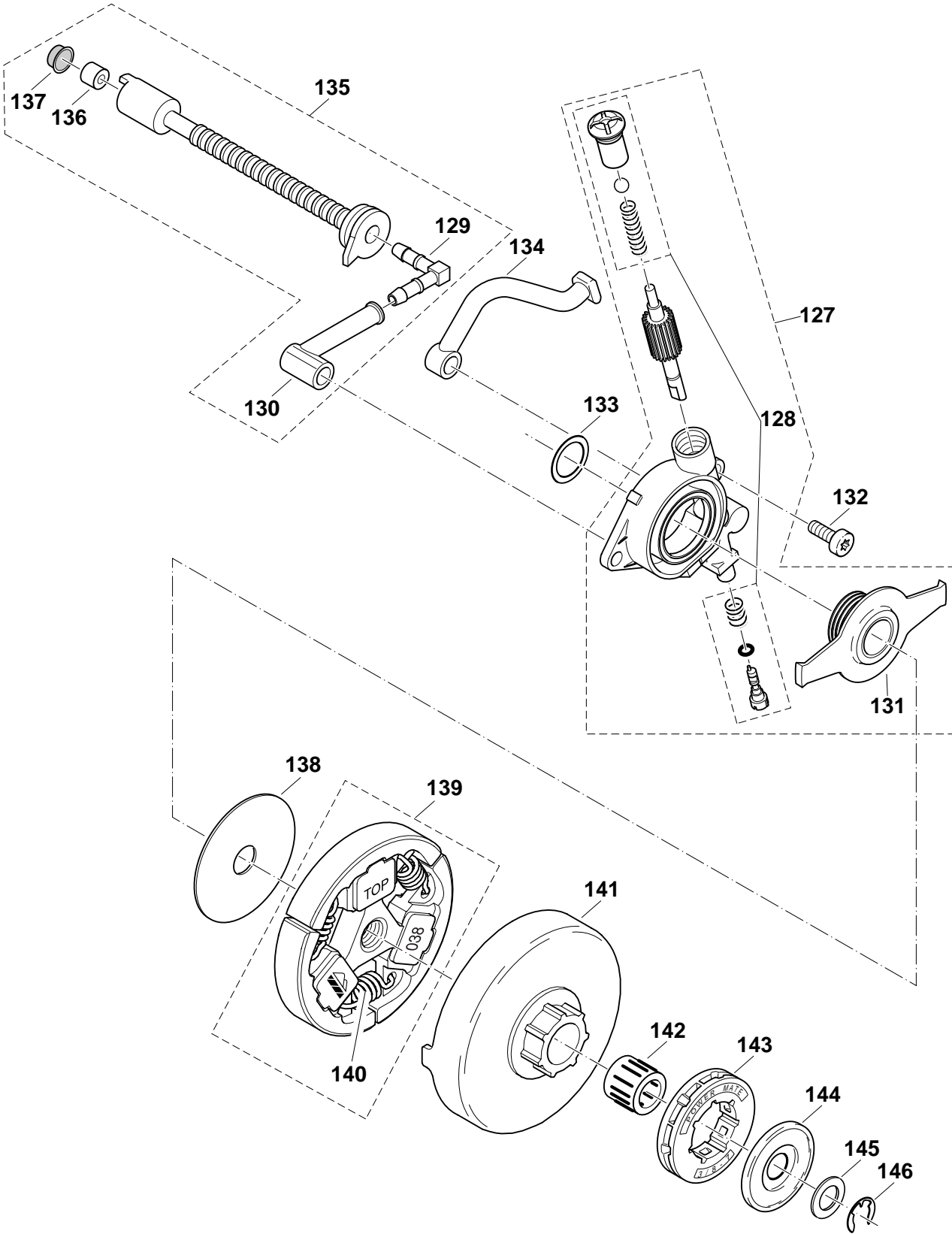

6) CHAIN BRAKE

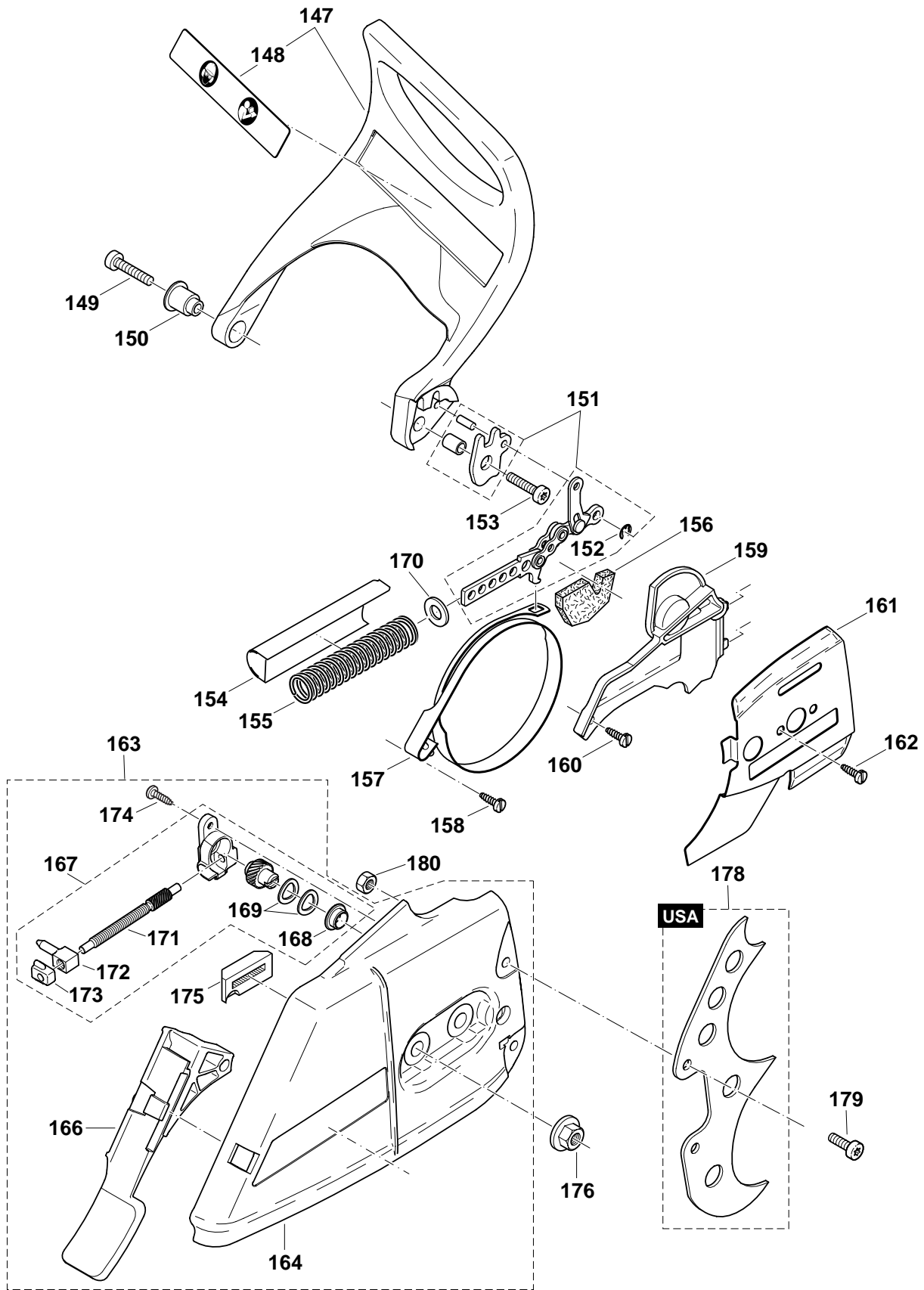

7) CARBURETOR

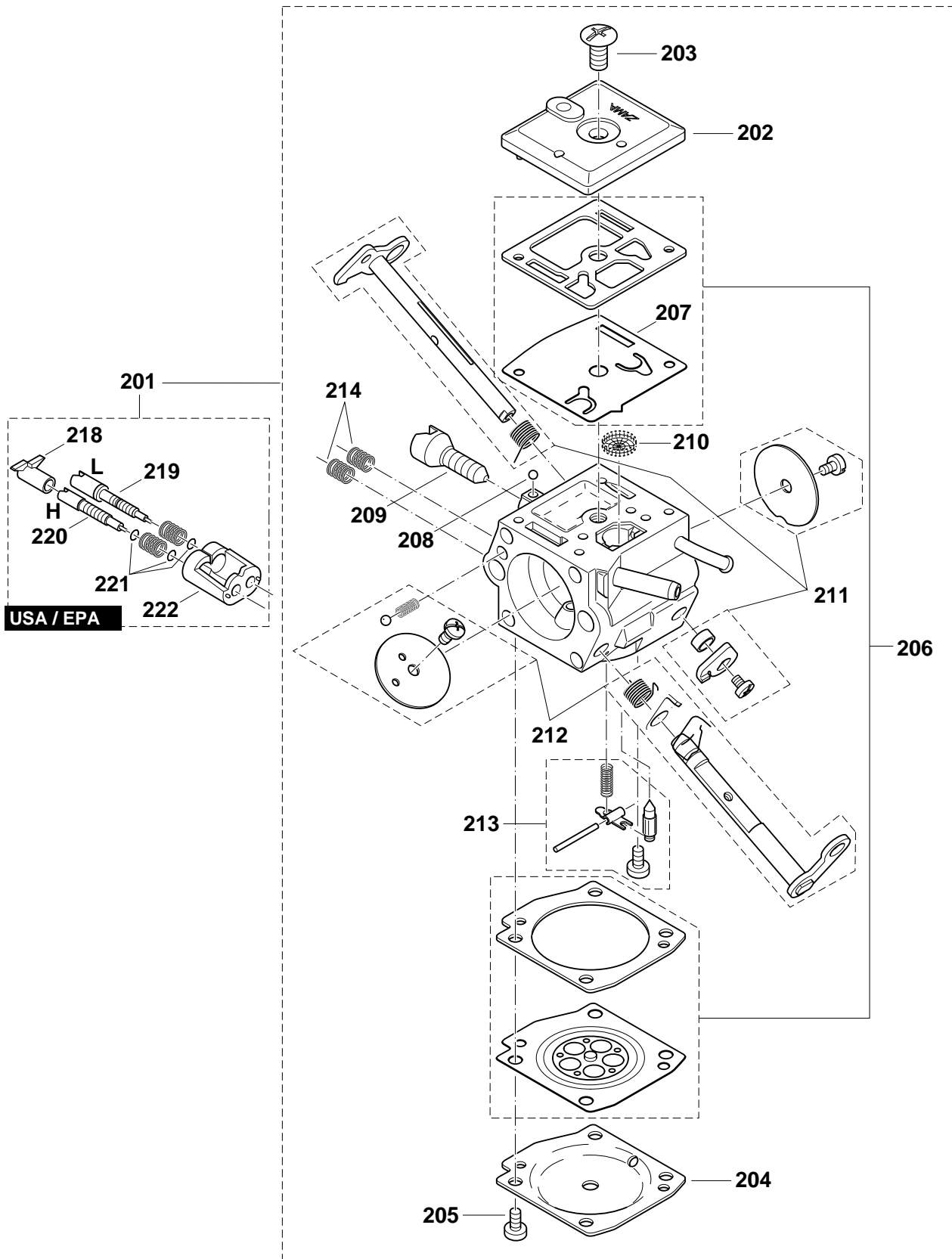

Item No.	Part No.	Qty. Used	Description	Item No.	Part No.	Qty. Used	Description
1	038-310-020	1	TUBULAR HANDLE ASSY	55	038-174-200	1	MUFFLER
2	038-310-060	1	CLAMP	56	038-174-040	1	SPARK ARRESTOR SCREEN
3	908-006-145	1	SCREW 6x14	57	915-035-100	1	SCREW 3.5x10
4	913-455-204	4	SCREW 5.5x20	58	965-531-130	1	GASKET
5	038-114-600	1	TANK CPL.,blue	59	038-174-020	1	COVER PLATE
6	957-114-060	1	AIR VALVE CPL.(fuel)	60	038-174-030	1	CONNECTING LINK
7	038-114-630	1	GRIP PLATE, blue	61	908-305-405	1	SCREW M5x40
8	038-117-020	1	CATCH LEVER	62	908-405-205	2	SCREW M5x20
9	038-117-030	1	ROCKER	63	038-130-030	1	CYLINDER/PISTON cpl.
10	038-117-010	1	THROTTLE LEVER	64	038-132-000	1	PISTON cpl.
11	038-117-050	1	SPRING	65	038-132-020	1	PISTON RING (D=52)
12	935-930-240	1	CYLINDRICAL PIN 3x24	66	038-132-040	1	PISTON PIN
13	935-930-280	1	CYLINDRICAL PIN 3x28	67	119-132-060	2	SPRING RING C12x1
14	010-117-040	1	BOWDEN CABLE	68	001-131-150	1	DECOMPRESSION VALVE
15	913-340-204	1	SCREW 4x20 S27	69	908-005-205	4	SCREW 5x20
16	038-114-050	1	FUEL LINE	70	038-114-150	1	SPRING w/threaded insert
17	975-001-210	1	SHORT-CIRCUIT SWITCH	71	965-531-121	1	GASKET
18	010-114-050	1	TANK CAP cpl.	72	038-120-020	1	CRANKSHAFT cpl.
19	963-228-030	1	PACKING RING 28x3	73	962-210-019	1	NEEDLE CAGE
20	963-601-130	1	SUCTION HEAD	74	960-102-159	1	BALL BEARING 6202
21	963-601-240	1	FELT for Suction Head	75	960-102-179	1	BALL BEARING 6203 C4
22	038-118-620	1	COVER, grey	76	038-111-630	1	CRANKCASE MAG.SIDE,blue
23	038-173-100	1	AIR FILTER cpl.	77	038-111-640	1	CRANKCASE CLUTCH SIDE,blue
24	038-173-010	1	AIR FILTER cpl.nylon	79	038-250-200	1	SPIKE BAR
25	038-118-630	1	BOTTOM, blue	80	038-111-080	1	CHAIN CATCH
26	038-118-110	2	RUBBER FLAP	81	908-005-165	1	SCREW 5x16
27	938-650-062	2	RIVET	82	010-114-050	1	TANK CAP cpl.
29	038-118-120	1	ADJUSTING GUIDE	83	963-228-030	1	PACKING RING 28x3
30	038-155-050	1	CHOKE SHAFT	86	962-900-052	1	RADIAL RING
31	038-155-020	1	CHOKE GUIDE	87	962-900-061	1	RADIAL RING 17x28x5/4
32	965-401-020	1	RUBBER BUSH	88	038-114-130	1	SPRING cpl.,w/cap
33	001-118-100	2	BUSHING	89	913-455-204	1	SCREW 5.5x20
34	038-155-060	2	SPACER L=30MM	90	038-114-130	1	SPRING cpl.,w/cap
35	908-005-205	2	SCREW 5x20	91	038-114-190	1	POT
36	001-118-100	2	BUSHING	92	913-455-204	1	SCREW
37	038-111-050	2	CLIP	93	038-114-140	1	SPRING cpl., w/cap
38	038-111-060	2	SQUARE NUT M5	94	908-005-305	6	SCREW 5x30
39	908-204-555	2	SCREW 4x55	95	936-430-160	2	SPIRAL CLAMPING PIN 3x16
40	921-804-004	2	SQUARE NUT M4	96	038-111-042	1	GASKET
41	038-155-010	1	RETAINING CLIP	97	934-660-250	1	SLOTTED PIN 6x24
42	038-131-030	1	INSERT for Suction Hose	98	908-005-125	1	SCREW 5X12
43	038-171-041	1	FLANGE	99	010-245-030	1	VENT VALVE
44	038-131-010	1	SUCTION HOSE	100	038-232-010	2	BOLT
45	965-603-050	1	HOSE CLAMP	101	038-160-600	1	STARTER ASSY.,blue
46	965-452-380	1	TUBE,L=65	102	928-405-000	1	SPRING WASHER
47	038-171-010	1	CONNECTING MUFF	103	038-112-630	1	FAN HOUSING, blue
48	038-118-690	1	HOOD cpl., grey	104	001-161-010	1	STARTER GRIP
49	038-118-140	1	INSERT	105	108-164-020	1	STARTER ROPE,(L=980MM)
50	038-118-130	1	CABLE GUIDE	106	985-000-155	1	STARTER ROPE, (L=100M)
51	917-105-205	2	SCREW M5x20	107	908-605-205	3	SCREW M5x20
52	038-171-030	1	HOLDER	108	038-162-021	1	CABLE DRUM cpl.
53	038-118-100	1	PLUG	109	924-605-510	1	WASHER 5.5x18x1.6
54	038-118-071	2	STEEL CLIP	110	913-455-204	1	SCREW 5.5x20

Item No.	Part No.	Qty. Used	Description	Item No.	Part No.	Qty. Used	Description
111	980-114-837	1	LABEL	164	038-213-635	1	SPROCKET GUARD, blue
112	038-112-020	1	AIR DUCT	166	038-213-190	1	CHIP GUIDE
113	970-502-110	1	INSULATING HOSE,L=140	167	957-213-020	1	CHAIN TENSIONER cpl.
114	038-143-020	1	IGNITION COIL	168	038-213-080	1	BUSHING
115	038-143-030	1	CABLE HARNESS	169	038-213-210	2	SPRING WASHER
116	957-604-240	1	PLUG CAP	170	028-213-010	1	WASHER 12x9
117	965-603-021	1	SPARK PLUG	171	038-213-120	1	TENSIONING SCREW
118	965-401-011	1	RUBBER BUSH	172	038-213-090	1	TENSIONING NUT
119	970-311-540	1	EARTH CABLE	173	038-213-070	1	TENSIONING SCREW BEARING
120	915-135-100	1	SCREW BZ3.5x9.5	174	915-135-100	1	SCREW BZ3.5x9.5
121	908-304-205	2	SCREW 4x10x20 S27	175	024-213-240	1	CHAIN GUIDE
122	038-111-110	2	CLIP	176	923-208-004	2	HEX. NUT M8
123	038-141-000	1	FLYWHEEL ASSY.	178	038-250-210	1	SPIKE BAR
124	108-166-051	2	STARTER RATCHET cpl.	179	908-005-125	2	SCREW M5x12
125	926-208-001	1	SPRING WASHER	180	920-405-000	2	HEX. NUT M5
126	920-208-024	1	HEXAGONAL NUT M8x1	181	038-162-050	1	SPACER
127	038-245-010	1	OIL PUMP cpl.	201	038-153-020	1	CARBURETOR (CM3)
128	030-245-070	1	REPAIR KIT	202	038-153-030	1	PUMP COVER
129	001-245-140	1	ANGULAR NIPPLE	203	038-153-360	1	SCREW
130	038-245-110	1	OIL LINE	204	038-153-040	1	DIAPHRAGM COVER
131	038-245-030	1	PUMP DRIVE	205	001-153-020	4	SCREW
132	908-005-125	2	SCREW 5x12	206	038-153-060	1	SET DIAPHRAGM/GASKETS
133	038-224-020	1	DISC	207	038-153-070	1	PUMP DIAPHRAGM
134	038-245-060	1	OIL LINE	208	038-153-210	1	LOCKING BALL
135	038-245-020	1	SUCTION LINE OIL cpl.	209	038-153-220	1	IDLE STOP SCREW (S)
136	900-005-066	1	DISTANCE RING	210	028-153-180	1	SCREEN
137	963-601-100	1	STRAINER SCREEN	211	957-153-060	1	KIT THROTTLE SHAFT
138	001-182-041	1	GUIDE DISC	212	957-153-050	1	KIT CHOKE SHAFT
139	038-180-010	1	CLUTCH ASSY.	213	957-153-070	1	CONTROL PARTS
140	024-184-021	3	SPRING	214	038-153-260	2	SPRING
141	038-223-020	1	CLUTCH DRUM	218	038-153-310	1	LIMITER CAP
142	962-210-024	1	NEEDLE CAGE 10x16x12	219	038-153-290	1	IDLE ADJUSTMENT SCREW-L
143	119-224-070	1	RIM SPROCKET, T=3/8"	220	038-153-300	1	MAIN ADJUSTMENT SCREW-H
144	001-224-011	1	DISC	221	038-153-250	3	WASHER
145	021-224-010	1	DISC	222	038-153-320	1	ADJUSTING GUIDE
146	927-408-000	1	WASHER, D=8x1.3				
147	038-213-220	1	HAND GUARD cpl.				
148	980-114-237	1	LABEL				
149	908-405-205	1	SCREW 5x20				
150	038-213-160	1	BUSHING				
151	957-213-030	1	BRAKING MECHANISM				
152	927-304-000	1	WASHER 4				
153	908-005-206	1	SCREW 5x20				
154	038-213-150	1	POT				
155	038-213-130	1	SPRING				
156	038-213-200	1	FOAM SPONGE				
157	038-213-010	1	BRAKE SPRING				
158	915-135-100	1	SCREW BZ3.5x9.5				
159	038-213-040	1	PLATE				
160	915-135-100	1	SCREW BZ3.5x9.5				
161	038-111-030	1	GUIDE PLATE				
162	915-135-100	1	SCREW BZ3.5x9.5				
163	038-213-600	1	SPROCKET GUARD cpl.,blue				