

MAIN VALVE ASSY. NO. 55047

CAUTION: HOLD THIS HEX WITH A WRENCH WHEN TIGHTENING FITTING. TORQUE ON THIS VALVE CAN CAUSE BREAKAGE.

COIL CLIP TOOL AND MAGAZINE

PART NO. 55450
TOOL STAND ASSEMBLY

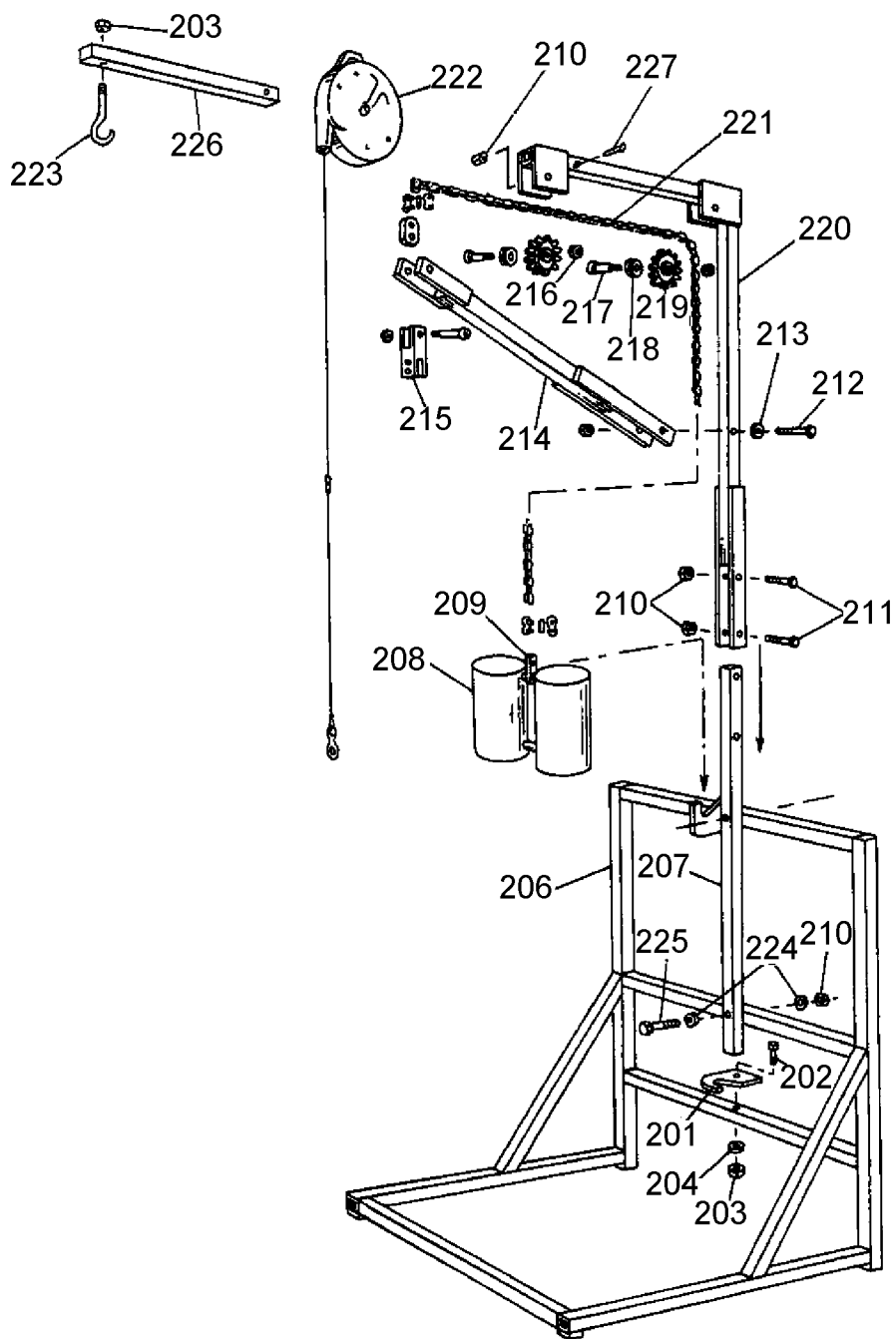

PART NO. 55435
DISPENSER & TRACK ASSEMBLY

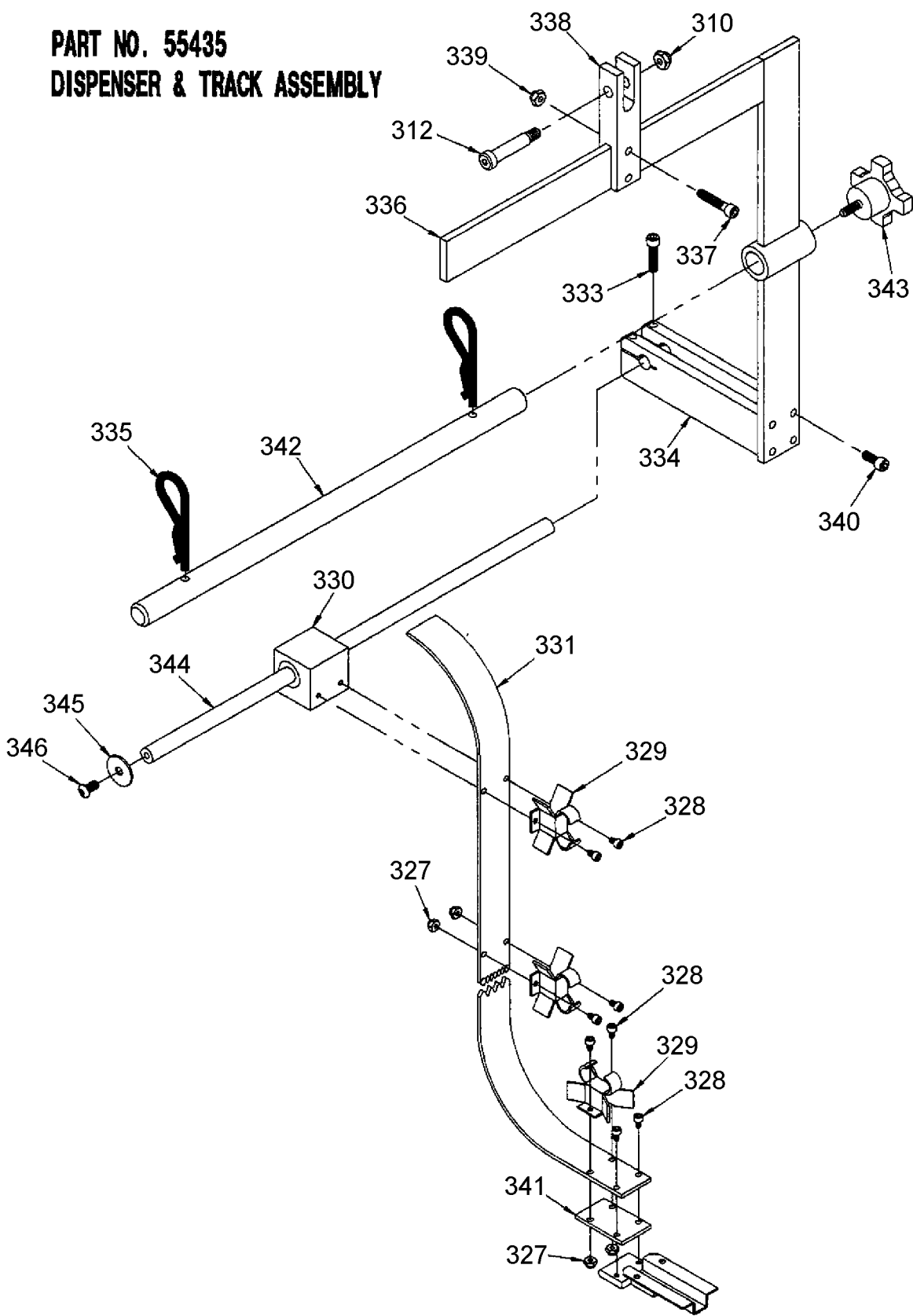

Parts List for HR-44 Type 0

Item Number	Part Number	Description	Qty Required
1	HR-55997	ANVIL	1
2	HR-55239	BLADE	1
3	HR-55232	BLADE GUIDE (CL-14 &	1
4	HR-15033	WASHER- LOCK #10	3
5	HR-56271	ANVIL HOLDER	1
6	HR-15327	BHCS 5/16-24 X 1	1
7	HR-55056	STUD-SHOULDER BOLT	1
8	HR-15028	SHCS 1/4-20 X 5/8	1
9	HR-15031	WASHER- LOCK 1/4 ID	5
10	HR-55970	PIN-FRONT PLATE	2
11	HR-55002	PIN - SIDE PLATE	3
12	HR-55012	TRIGGER COMPLETE	1
13	HR-15328	RING	4
14	HR-15061	BHCS 1/4-20 X 1/2	2
15	HR-55004	SIDE PLATE- L.H.	1
16	HR-55003	SIDE PLATE- R.H.	1
18	HR-55017	YOKE - PISTON ROD	1
19	HR-55008	LINK	2
20	HR-55103	ROLLER	1
22	HR-55009	PIN- DOWEL 5/16 X 1	1
23	HR-55018	PISTON PIN - ROLLER	1
24	HR-15004	PIN- DOWEL 1/8 X 7/8	2
25	HR-55019	PISTON ROD W/ O-RING	1
26	HR-15054	O-RING	1
27	HR-15014	O-RING 3/8 X 1/2 X 1	2
28	HR-55926	HANGER ASSEMBLY	1
29	HR-15000	BHCS 1/4-20 X 5/8	1

Parts List for HR-44 Type 0

Item Number	Part Number	Description	Qty Required
30	HR-15001	SHCS 1/4-20 X 3/4	5
32	HR-15002	PIN- ROLL 3/32 x 1/2	3
33	HR-55397	BRACKET ASSEMBLY	1
34	HR-15037	ROLLER BEARING	1
35	HR-55095	HANGER YOKE	1
36	HR-15038	WASHER- FLAT 3/8 X 1	2
37	HR-15316	BHCS 1/4-20 X 1	1
38	HR-15023	NUT- FLEXLOC 1/4-20	1
39	HR-55094	HANGER YOKE ASSEMBLY	1
40	HR-55020	HOUSING CL-CC-TM	1
41	HR-15010	O-RING VITON 9/16 X	2
42	HR-15015	O-RING VITON 1 X 1 1	1
43	HR-15011	O-RING 1/4 X 3/8 X 1	1
44	HR-15012	O-RING 3/8 X 9/16 X	2
45	HR-15013	O-RING 5/8 X 3/4 X 1	2
46	000000-00	No Longer Available	1
46	HR-56177	VALVE PISTON	1
47	000000-00	No Longer Available	1
47	HR-56170	VALVE BODY	1
48	HR-55013	VALVE LEVER CL-CC	1
49	HR-55014	PILOT VALVE BODY CL-	1
50	HR-15008	O-RING 1/8 X 1/4 X 1	1
51	HR-55015	VALVE STEM CL-CC	1
52	HR-55016	SPRING CL-CC	1
53	HR-15009	O-RING 5/16 X 7/16 X	1
54	HR-15017	O-RING 2 3/4 X 3 1/8	1
55	HR-55021	PISTON CL-CC-AK-LN-T	1

Parts List for HR-44 Type 0

Item Number	Part Number	Description	Qty Required
56	HR-15016	O-RING 2 7/8 X 3 X 1	1
57	HR-15029	WASHER- LOCK 5/16 ID	1
58	HR-55022	PISTON SCREW	1
59	HR-15005	PIN- ROLL 5/32 X 1	1
60	HR-55401	CAP CC	1
61	HR-15063	SHCS 1/4-20 X 1-1/4	1
62	HR-55109	MAGAZINE SPACER CL-C	1
63	HR-55420	BRACKET	1
64	HR-55426	PLATE	1
65	HR-15044	NUT- FLEXLOC 10-24	6
67	HR-15022	SHCS 1/4-20 X 1	1
68	HR-15047	WASHER- FLAT 1/4 X 5	7
69	HR-55429	ANTI-BACKUP WHEEL	2
70	HR-55428	SHAFT- BEARING	2
71	HR-15236	ANTI-BACKUP BEARING	2
72	HR-55411	LEVER	2
73	HR-55410	WHEEL ARM SPRING CC-	2
74	HR-55412	LEVER SPACER	2
75	HR-15021	SHCS 10-32 X 1/2 W/N	10
76	HR-55415	CYLINDER	1
77	HR-55416	PISTON	1
78	HR-55417	CYLINDER CAP	1
79	HR-15234	SHSS 1/4 X 1	2
80	HR-55427	LEVER LIFT	2
81	HR-15244	O-RING 7/16X5/8X3/	1
82	HR-15243	O-RING 1/2X5/8X1/1	1
83	HR-55413	SPACER- CYLINDER	1

Parts List for HR-44 Type 0

Item Number	Part Number	Description	Qty Required
85	HR-15073	SHCS 1/4-20 X 1 1/2	2
86	HR-15033	WASHER- LOCK #10	2
87	HR-55408	MAGAZINE SUPPORT BRA	2
88	HR-55407	COVER- RAIL	1
89	HR-15235	SHSS 1/4 X 1 1/4	1
90	HR-55423	LEVER- CRANK	1
91	HR-55409	PAWL	1
92	HR-55406	SPRING	1
93	HR-55424	SPRING ROD GUIDE	1
94	HR-55419	CRANK SPACER	1
95	HR-55418	CRANK	1
96	HR-55414	PIN- PISTON	1
97	HR-15078	SHCS 1/4-20 X 1 3/4	1
98	HR-55422	ASSEMBLY- SPRING	2
99	HR-55431	ASSEMBLY- SPRING SUP	1
100	HR-55425	SPACER	1
101	HR-55421	PLATE	1
103	HR-55405	CYLINDER TUBE CC	1
104	HR-15331	1/4 TUBE FITTING	2
105	HR-15204	3/8 COUPLER PLUG	1
106	HR-15034	1/4 STREET ELBOW STE	1
201	HR-55455	COUNTER WEIGHT LATCH	1
202	HR-15078	SHCS 1/4-20 X 1 3/4	1
203	HR-15023	NUT- FLEXLOC 1/4-20	2
204	HR-15047	WASHER- FLAT 1/4 X 5	1
209	HR-55457	CHAIN CONNECTING LIN	2
210	HR-15046	NUT- FLEXLOC 5/16-18	7

Parts List for HR-44 Type 0

Item Number	Part Number	Description	Qty Required
211	HR-15103	SHCS 5/16-18 X 2	2
212	HR-15113	SHSS 3/8 X 1 1/2	2
214	HR-55459	PIVOT ARM ASSEMBLY	1
215	HR-55437	PIVOT LINK	1
216	HR-15126	NUT- FLEXLOC 3/8-16	2
217	HR-15246	SHSS 1/2 X 1 1/4	2
219	HR-55448	SPROCKET ASSEMBLY	2
222	132979-S	ASSEMBLY, BALANCER	1
225	HR-15778	SHCS 5/16-18 X 3 1/2	2
226	HR-55995	EXTENSION ARM	1
227	HR-15082	SHCS 5/16-18 X 1 1/2	1
310	HR-15046	NUT- FLEXLOC 5/16-18	1
312	HR-15113	SHSS 3/8 X 1 1/2	1
327	HR-15020	NUT- THIN JAM FLEXLO	26
328	HR-15019	SHCS 8-32 X 1/4	30
329	HR-55436	TRACK CLIP GUIDE (7/	14
330	HR-55442	TRACK CARRIAGE ASSEM	1
331	000000-00	No Longer Available	1
331	HR-55478	CLIP TRACK (7/8)	1
333	HR-15022	SHCS 1/4-20 X 1	2
337	HR-15063	SHCS 1/4-20 X 1-1/4	2
338	HR-55437	PIVOT LINK	1
339	HR-15023	NUT- FLEXLOC 1/4-20	2
340	HR-15028	SHCS 1/4-20 X 5/8	4
341	HR-55446	TRACK STIFFENER (7/1	1
342	HR-56305	DISPENSER SHAFT	1
346	HR-15061	BHCS 1/4-20 X 1/2	1

Parts List for HR-44 Type 0

Item Number	Part Number	Description	Qty Required
800	100653	LUBE (2CC)	1
800	100679	LUBE (1LB.CAN)	1