

Key No.	Torque
155	25 to 30 Ft. Lbs.
157	25 to 30 Ft. Lbs.
163	13 to 17 In. Lbs.
175	7 to 10 Ft. Lbs.
179	9 to 12 Ft. Lbs.
188	15 to 20 Ft. Lbs.

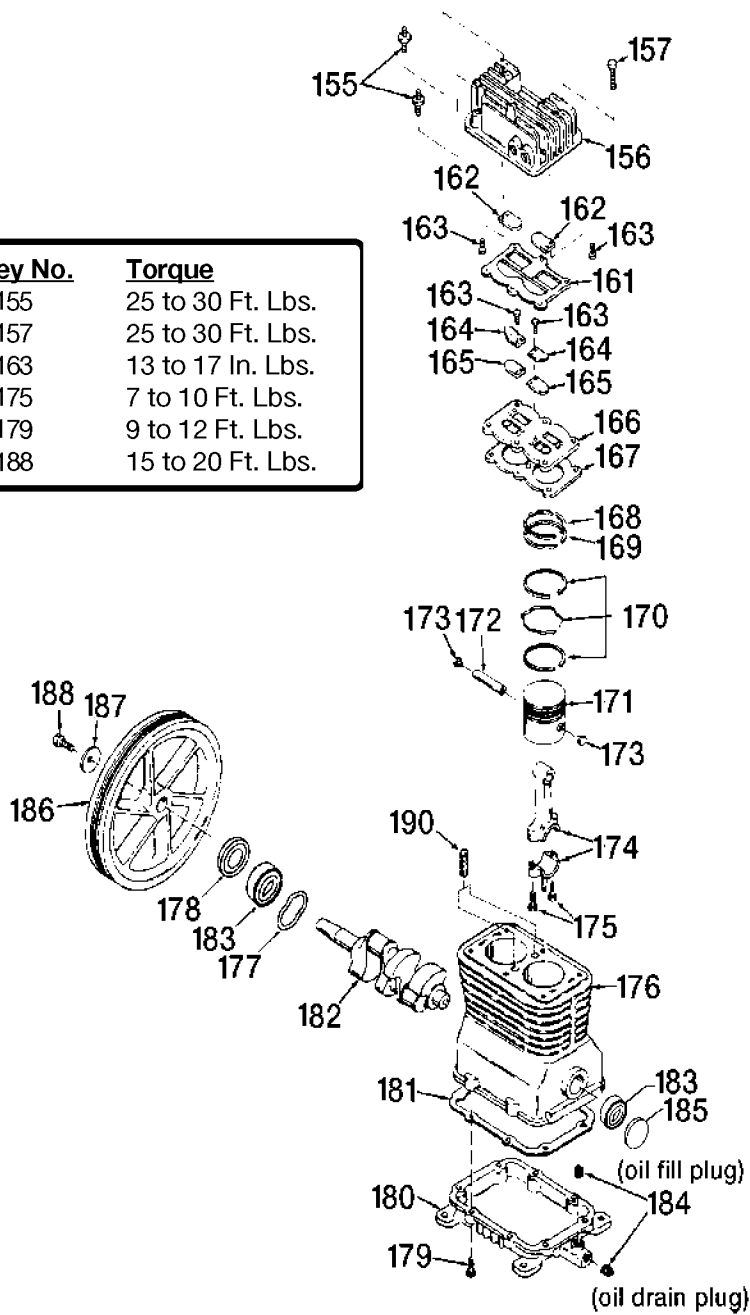

Recommended Oils - One Stage Compressor Units

Use a compressor oil such as SAE 20-20W SF motor oil. (Crankcase oil capacity is 16 fluid ounces.) Under extreme winter conditions use 10 weight oil. Multiviscosity oil, 10W30, will leave carbon deposits on critical components, reducing performance and compressor life.

Parts List for IRL5G20 Type 0

Item Number	Part Number	Description	Qty Required
1	SSF-953-ZN	SCREW #10X.625 HHW S	7
2	CAC-87-1	BELTGUARD	1
3	CAC-437-2	VALVE CHECK 1/2NPT X	1
4	SSP-7812	ASSY NUT SLEEVE 1/2	2
5	SSP-7811	ASSY NUT SLEEVE 1/4	3
6	AC-0675	TUBE OUTLET .50 OD A	1
7	000000-00	No Longer Available	1
8	SSP-6422	ELBOW	3
10	000000-00	No Longer Available	1
11	000000-00	No Longer Available	1
12	SSF-8113-ZN	NUT .375-16X.563 HEX	1
14	5140123-08	SCREW	2
15	265-18	RETAINER FILTER	1
16	265-17	FILTER FELT	1
18	000000-00	No Longer Available	1
20	SSF-928	SCREW .313-18X.875 H	6
21	Z-CAC-423	ASSY UNLOADER	1
22	TIA-4150	VALVE SAFETY 150 .25	1
23	000000-00	No Longer Available	1
24	SS-3222-CD	PLUG PIPE	1
25	000000-00	No Longer Available	1
26	000000-00	No Longer Available	1
27	SS-2110	NIPPLE GALV 3/8 X 3	1
28	SSF-8111-ZN	NUT .375-16 HEX WHIZ	1
31	000000-00	No Longer Available	2
32	CAC-60	BOLT .375-16X2.25 UN	2
33	SSF-8080-ZN	NUT .375-16 UNC-2B H	2

Parts List for IRL5G20 Type 0

Item Number	Part Number	Description	Qty Required
34	N286039	DRAIN VALVE	1
35	SS-656-CD	NUT .313-18 UNC HEX	8
36	5130235-00	LOCK WASHER	8
37	CAC-165	VIBRATION MOUNT	4
38	330016-13	WASHER	1
39	SS-391	SCREW .250-20 .625 S	1
40	A07639	SCREW	4
41	000000-00	No Longer Available	2
42	038738-00	NUT	4
43	DAC-159	BRACKET FOOT BLACK I	1
44	904030301757	LOCK WASHER	2
46	SUDL-43-1	HANDLE PULL BLACK IC	1
47	000000-00	No Longer Available	1
49	D22996	SCREW .313-18X1.50 U	4
50	AC-0677	TUBE THROTTLE CONTRO	1
51	Z-CAC-4275	ASSY AIR CYLINDER	1
52	Z-CAC-4275	ASSY AIR CYLINDER	1
53	000000-00	No Longer Available	1
54	Z-CAC-4275	ASSY AIR CYLINDER	1
55	Z-CAC-4275	ASSY AIR CYLINDER	1
56	000000-00	No Longer Available	1
57	000000-00	No Longer Available	1
58	C-BT-215	BELT 6J 45.8 EFF	1
59	000000-00	No Longer Available	1
60	SS-391	SCREW .250-20 .625 S	1
61	C-PU-2862	PULLEY 6J-SEC 2.80 O	1
62	CAC-142	CLOSURE BELTGUARD	1

Parts List for IRL5G20 Type 0

Item Number	Part Number	Description	Qty Required
63	SSF-8150	NUT .312-18 UNC HEX	1
64	000000-00	No Longer Available	1
65	SSF-8150	NUT .312-18 UNC HEX	1
155	SSF-6627	STUD SHOULDER 3/8-16	2
156	Z-CAC-4213	ASSY HEAD	1
157	SSF-955	SCREW .375-16X1.50 H	4
161	5140118-80	GASKET	1
162	KK-4275	KIT VALVE	1
163	KK-4275	KIT VALVE	1
164	CAC-294	PLATE RESTRICTOR	2
165	KK-4275	KIT VALVE	1
166	Z-CAC-4212-1	ASSY VALVE PLATE	1
167	5140118-79	GASKET	1
168	000000-00	No Longer Available	1
169	000000-00	No Longer Available	1
170	000000-00	No Longer Available	1
171	CAC-55-1	PISTON MACHINE DWG 2	2
172	265-19	PIN PISTON	2
173	CAC-207	PLUG PISTON PIN	4
174	265-410	ASSY CONNECTING ROD	1
175	SSF-927	SCREW .250-20X1.125	4
176	Z-AC-0205	CRANKCASE & CYLINDER	1
177	SSN-1018	WASHER WAVY SPRING 2	1
178	AC-0169	SEAL OIL	1
179	SSF-925	SCREW .250-20X.875 H	8
180	000000-00	No Longer Available	1
181	265-16-1	GASKET BASE	1

Parts List for IRL5G20 Type 0

Item Number	Part Number	Description	Qty Required
182	Z-D22270	CRANKSHAFT MACH BALL	1
183	SST-104	BEARING 6205C3	2
184	SSP-486	PLUG PIPE 3/8 - 18 N	2
185	SSP-505	PLUG 52MM OIL	1
186	265-2	FLYWHEEL 10 OD CI PO	1
187	SSN-1014-ZN	WASHER .339/.344 ID	1
188	SSF-3039-ZN	SCREW .313-18X.750 H	1
190	265-6	VENT FILTER	2
856	5140118-37	GASKET KIT	1
856	000000-00	No Longer Available	1
856	KK-4275	KIT VALVE	1