

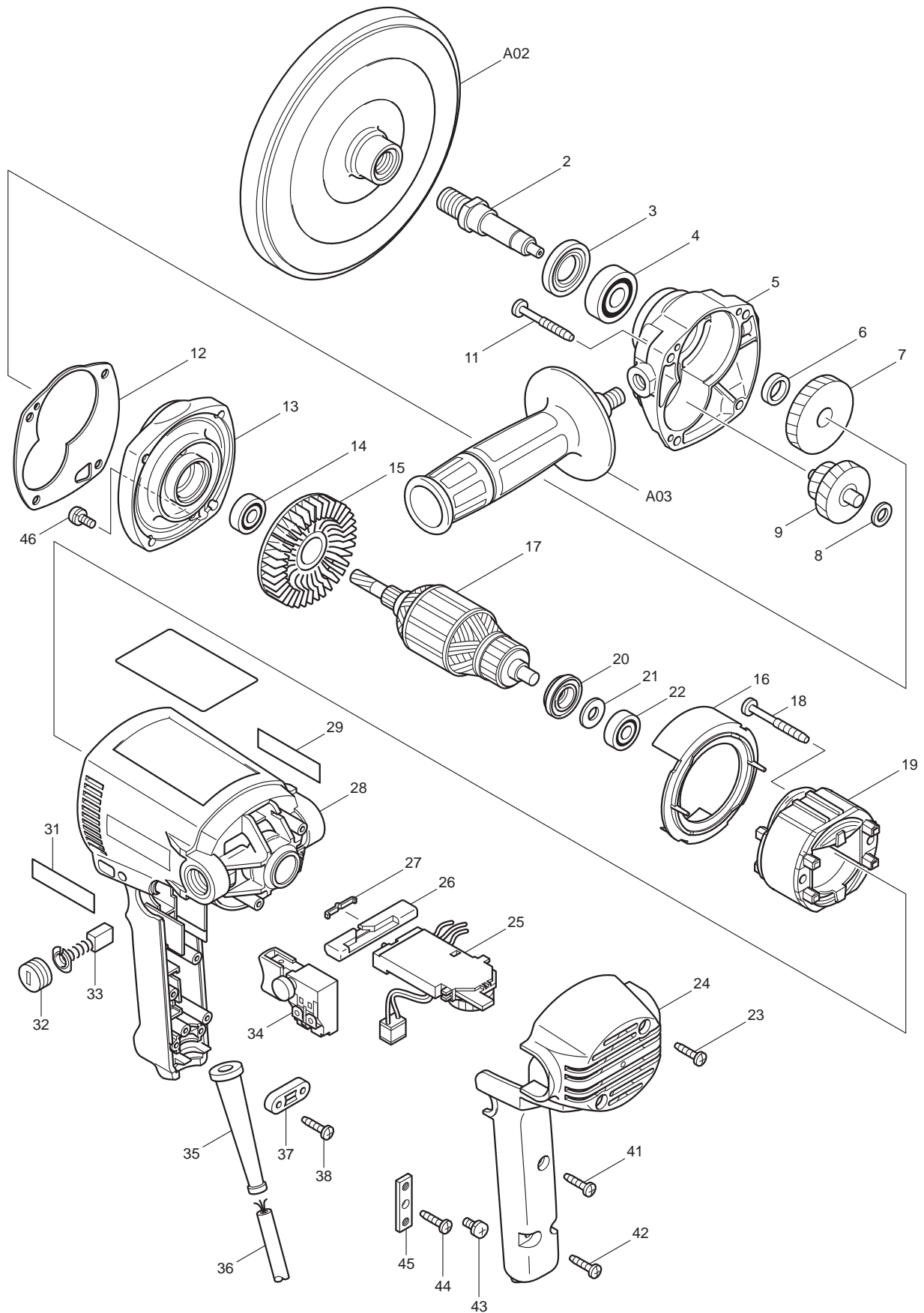

02 - 2010
PV7001C
7" POLISER
W/ ELECTRONIC SPEED CONTROLLER



Item No.	Type	Sub	Part No.	Description (*See Service changes on bottom)	Qty	Unit
2			324081-3	SPINDLE	1	PC.
3			152690-6	BEARING RETAINER COMPLETE	1	PC.
		INC.	213209-7	OIL SEAL 16	1	PC.
4			211129-9	BALL BEARING 6201DDW	1	PC.
5	1		152691-4	* GEAR HOUSING COMPLETE	1	PC.
		INC.	210018-5	* BALL BEARING 626	1	PC.
	2		153318-9	* GEAR HOUSING COMPLETE	1	PC.
		INC.	210018-5	* BALL BEARING 626	1	PC.
6			257707-1	SLEEVE 12	1	PC.
7			226536-3	HELICAL GEAR 43	1	PC.
8			253215-0	FLAT WASHER 8	1	PC.
9			226141-6	GEAR COMPLETE 21-44	1	PC.
11			266211-9	TAPPING SCREW 5X40	4	PC.
12	1		442132-1	* GASKET	1	PC.
	2		417837-2	* GASKET	1	PC.
13	1		152692-2	* GEAR HOUSING COVER COMPLETE	1	PC.
		INC.	212016-5	* NEEDLE BEARING 609	1	PC.
		INC.	214028-4	* PLANE BEARING 8	1	PC.
	2		153319-7	* GEAR HOUSING COVER COMPLETE	1	PC.
		INC.	212016-5	* NEEDLE BEARING 609	1	PC.
		INC.	214028-4	* PLANE BEARING 8	1	PC.
14			210005-4	BALL BEARING 608DDW	1	PC.
15			240020-4	FAN 65	1	PC.
16	1		413077-0	BAFFLE PLATE	1	PC.
	2		419721-7	BAFFLE PLATE	1	PC.
17			516431-8	ARMATURE ASS'Y 115V	1	PC.
		INC.		Item No. 14,15,20-22		
18			266056-5	TAPPING SCREW 5X45	2	PC.
19			594386-7	FIELD ASS'Y 115V	1	PC.
		INC.	654020-2	RING TERMINAL	1	PC.
		INC.	654501-6	CONNECTOR P-1.25	1	PC.
20			681660-3	INSULATION WASHER	1	PC.
21			253139-0	FLAT WASHER 8	1	PC.
22			210005-4	BALL BEARING 608DDW	1	PC.
23			265995-6	TAPPING SCREW 4X18	2	PC.
24			417450-6	HANDLE COVER	1	PC.
25			631426-1	CONTROLLER	1	PC.
26			417449-1	LEVER	1	PC.
27			232201-4	LEAF SPRING	1	PC.
28			183300-4	MOTOR HOUSING SET	1	SET
		INC.		Item No. 29,31		
29			819063-3	MAKITA LABEL	1	PC.
31			819063-3	MAKITA LABEL	1	PC.
32			643750-0	BRUSH HOLDER CAP	2	PC.
33	1		191963-2	CARBON BRUSH CB-303 2PC/SET (W/O ORIGIN)	1	SET
	2		194996-6	CARBON BRUSH CB-303 2PC/SET (W/ ORIGIN)	1	SET
34			651297-0	SWITCH	1	PC.
35			682559-5	CORD GUARD 8	1	PC.
36			664625-0	CORD W/PLUG 3P-18-2.5M, SJ (OLD# 664124-2)	1	PC.
37			687063-9	CORD CLAMP	1	PC.
38			265995-6	TAPPING SCREW 4X18	2	PC.
41			265995-6	TAPPING SCREW 4X18	1	PC.
42			265995-6	TAPPING SCREW 4X18	2	PC.
43			652014-1	PAN HEAD SCREW M4X8	2	PC.
44			265995-6	TAPPING SCREW 4X18	1	PC.
45			654571-5	TERMINAL BLOCK	1	PC.
46			652014-1	PAN HEAD SCREW M4X8	1	PC.

Item No.	Type	Sub Part No.	Description (*See Service changes on bottom)	Qty	Unit
47		417793-6	* COVER (Added)	1	PC.
48		256157-7	* PIN 3 (Added)	1	PC.
100		652008-6	P.H. Screw M3.5X7	4	PC.
101		654037-5	INSULATED EYE TERMINAL RBV1.25-3	3	PC.
102		654038-3	INSULATED EYE TERMINAL FV1.25-M4	2	PC.
103		654077-3	INSULATED EYE TERMINAL FV2-M3	1	PC.
104		654213-1	TERMINAL	1	PC.
105		654509-0	CONNECTOR 2-SD	1	PC.



ACCESSORIES

- See Catalogue or Visit www.makita.ca for Optional Accessories -

A01		781008-0	WRENCH 17	1	PC.
A02		743052-5	PAD 165	1	PC.
A03		152491-2	GRIP 36 COMPLETE	1	PC.

SERVICE CHANGES

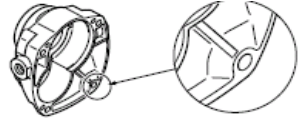
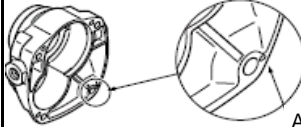
1. Changes on Gear Housing, Gasket, etc.

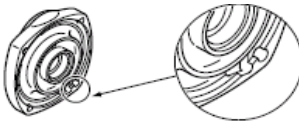
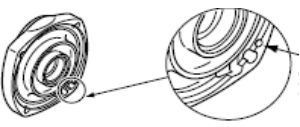
Item No.	Description	Type 1	Type 2
5	Gear Housing Complete	152691-4	153318-9
			 A hole for Pin 3 is added
12	Gasket	442132-1	417837-2
			 A hole for Pin 3 is added
13	Gear Housing Cover Com.	152692-2	153319-7
			 A hole for Pin 3 is added
48	Pin 3	-----	256157-7

2. Addition of Cover

Item No.	Description	Type 1	Type 2
47	Cover	-----	417793-6

