



SERVICE PARTS LIST

BUL. 54-06-1402

1/4" PISTOL DRILL

REVISED BUL 54-06-0401 DATE July '72

Catalog No. 0190

Starting Serial No. **304-10099**

WIRING INSTR. **58-01-0010**

Both Model and Serial No. must be furnished to obtain correct parts.

1700 R.P.M.

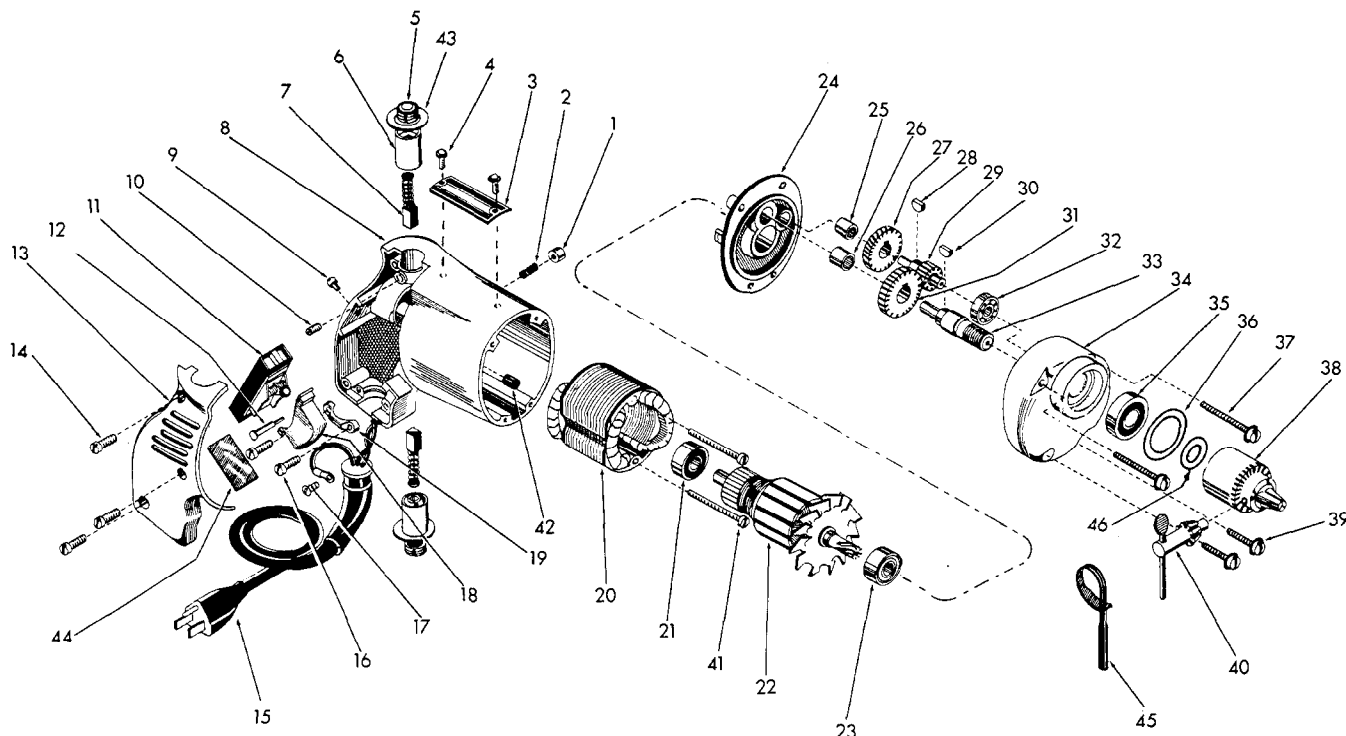

FIG.	PART NO.	DESCRIPTION OF PART	NO.REQ.
1	42-42-0061	Trigger Lock Button	
2	40-50-1200	Trigger Lock Spring	
★ 3	12-99-0020	Name Plate	
4	06-85-0200	Name Plate Screw	(2)
5	23-44-0020	Brush Retaining Cap	(2)
6	22-22-0050	Brush Holder Assembly	(2)
7	22-18-0090	Carbon Brush Assembly	(2)
8	28-50-4447	Motor Hsg. (Inc. Fig. Nos. 1, 2, 12, 13, 14 & 42)	
9	06-81-5800	6-32 x 5/16 Fil. Hd. Sems	
10	06-83-2430	10-32 x 1/4 Skt. Hd. Set Screw	(2)
11	23-66-0280	Switch	
	06-97-1800	Switch Lock Washers	(4)
12	44-70-0071	Trigger Lock Shaft	
13	28-20-3002	Handle Cover	
14	06-81-6150	8-32 x 1/2 Fil. Hd. Sems	(3)
15	22-64-0170	Cord Set	
16	06-81-6150	8-32 x 1/2 Fil Hd. Sems	(2)
17	06-81-8625	Ground Screw	
18	31-92-0102	Switch Trigger	
19	28-17-0400	Cord Clamp	
20	18-22-1030	Field	
21	02-04-0740	Ball Bearing	
22	16-22-1120	Armature Assembly	
23	02-04-0880	Ball Bearing	

FIG.	PART NO.	DESCRIPTION OF PART	NO.REQ.
24	28-28-0221	Diaphragm	
25	02-50-1210	Needle Bearing	
26	02-50-1640	Needle Bearing	
27	32-40-1041	Intermediate Gear	
28	06-42-0400	Woodruff Key	
29	36-66-3701	Intermediate Pinion Shaft	
30	06-42-0800	Woodruff Key	
31	32-75-2381	Spindle Gear	
32	02-04-0640	Intermediate Shaft Ball Bearing	
33	38-50-1051	Spindle	
★ 34	28-14-0363	Gear Case	
35	02-04-1020	Ball Bearing	
★ 36	34-80-1400	Retaining Ring	
★ 37	06-81-6575	8-32 x 1-5/8 Fil. Hd. Sems	(2)
38	48-66-0260	Chuck	
★ 39	06-81-6350	8-32 x 1 Fil. Hd. Sems	(2)
40	48-66-3200	Chuck Key	
41	06-81-5950	6-32 x 1-7/8 Fil. Hd. Screws	(2)
42	45-30-0060	Ball Bearing Ret. Slug	
★ 43	23-86-0105	Insulating Washer	(2)
44	23-16-0265	Switch Insulator	
45	48-66-4080	Key Holder	
★ 46	45-88-0080	Chuck Washer	