

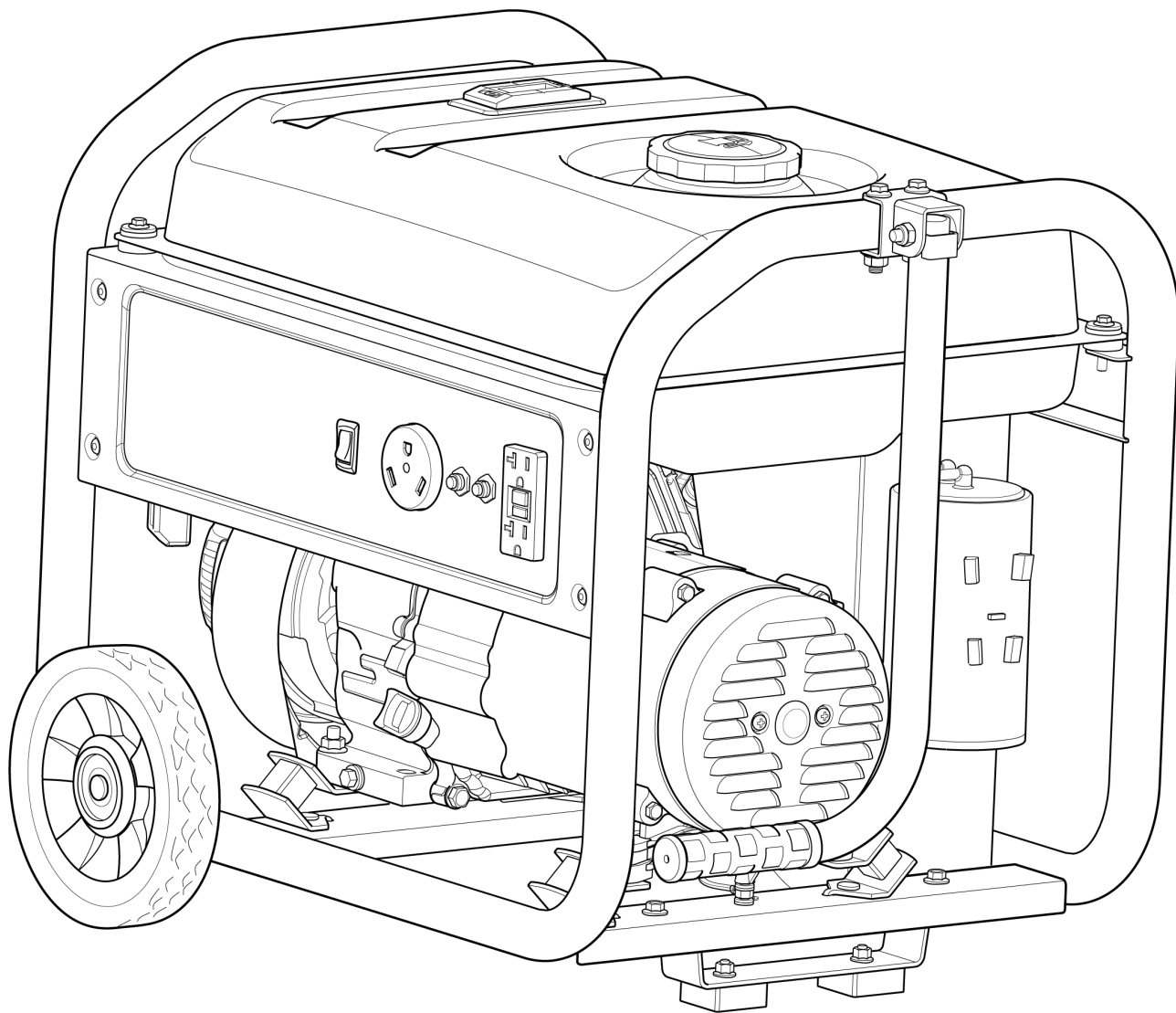

# Parts Manual

Mfg. No: 030743-01  
3,500 Watt, Briggs & Stratton 50 State



# Control Panel

Note: Unless noted otherwise, use the standard torque specifications

Mfg. No: 030743-01

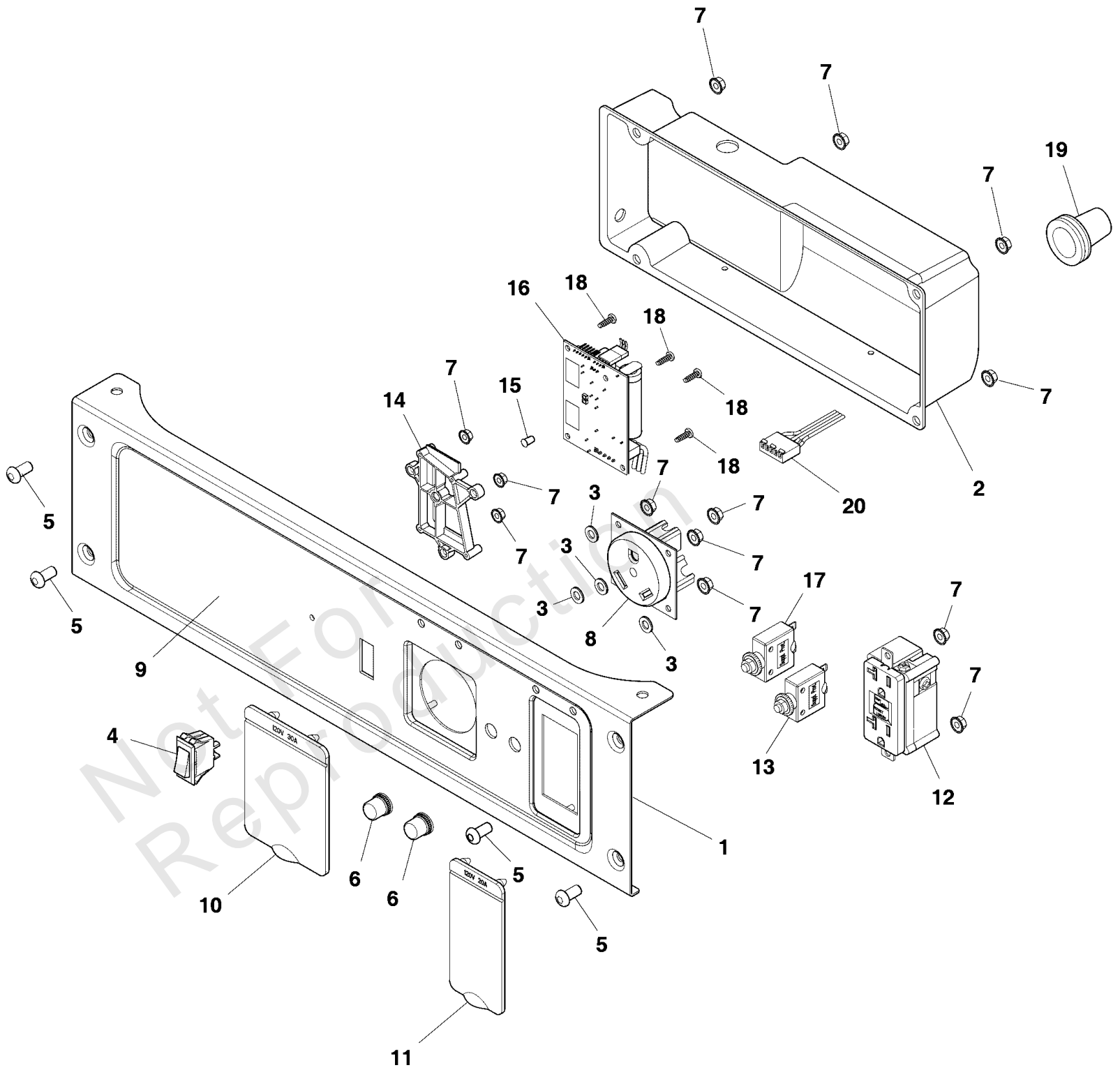

## Control Panel

REF NO	PART NO	QTY	DESCRIPTION
1	84002326	1	PANEL-CONTROL -(Includes Item 9)
2	84002324	1	BOX-CONTROL PANEL
3	84002325	1	WASHER-FLAT
4	319525GS	1	SWITCH-ON/OFF
5	772229	4	SCREW
6	312636GS	2	BOOT, Circuit Breaker
7	795016	13	NUT
8	704904	1	OUTLET
9	84002323	1	DECAL
10	84002322	1	COVER-OUTLET
11	319476GS	1	COVER-OUTLET
12	709526	1	OUTLET-GFCI
13	318061GS	1	BREAKER-CIRCUIT, 20A
14	772213	1	BRACKET-MODULE
15	772217	1	LIGHT-PIPE
16	84005244	1	MODULE-CO
17	318063GS	1	BREAKER-CIRCUIT, 30A
18	84001081	4	SCREW
19	312741GS	1	GROMMET
20	84002319	1	HARNESS-WIRING

# Main Unit

Note: Unless noted otherwise, use the standard torque specifications

Mfg. No: 030743-01

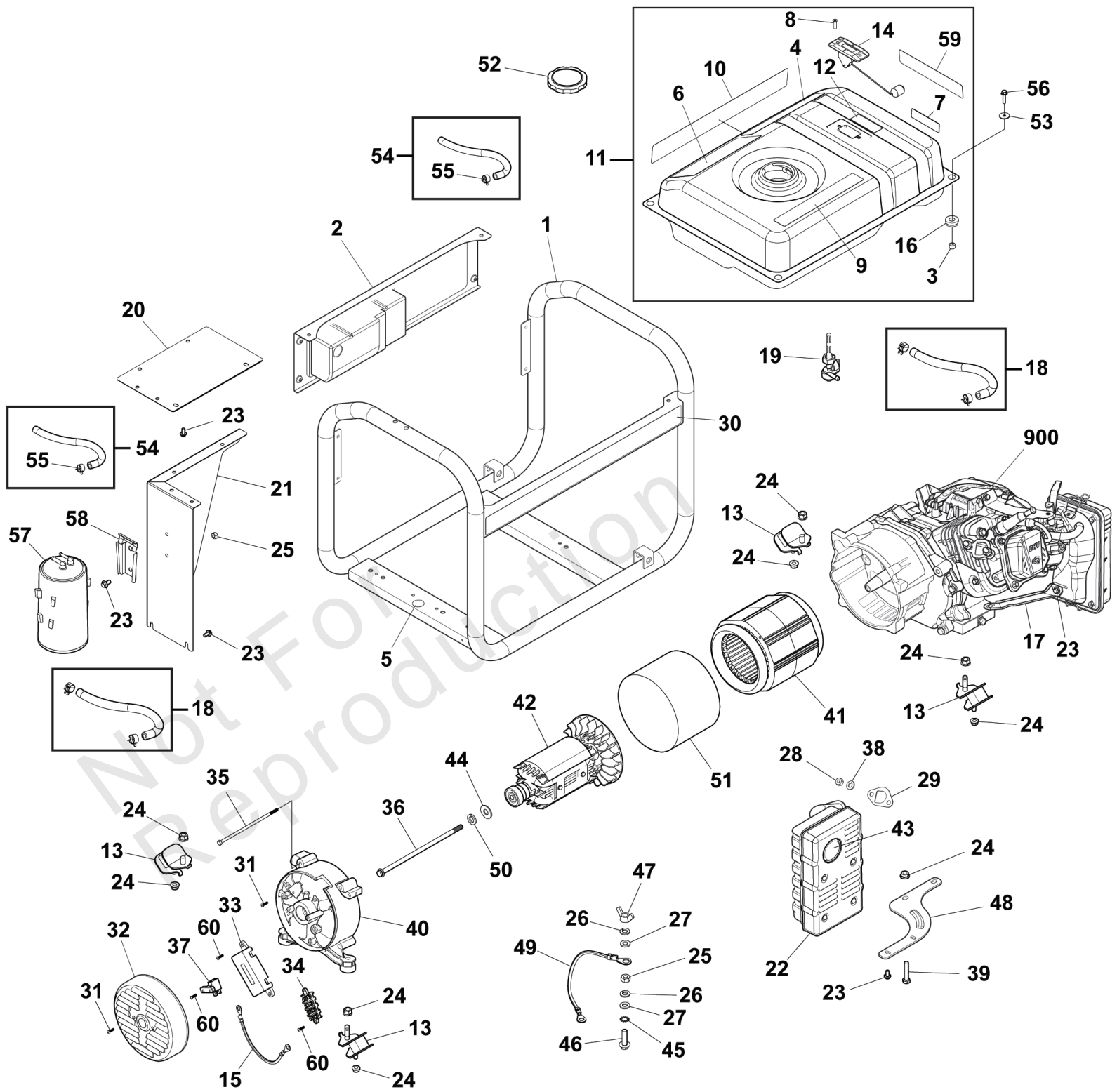

## Main Unit

REF NO	PART NO	QTY	DESCRIPTION
1	84002344	1	CRADLE -(Includes Items 5 & 30)
2	REF-80078852	1	Refer to: Control Panel Group
3	189137GS	4	SPACER
4	84002345	1	DECAL
5	704331	1	DECAL
6	84001068	1	DECAL
7	772236	1	DECAL
8	314440GS	1	SCREW
9	772237	1	DECAL
10	84002342	1	DECAL
11	84002346	1	TANK, FUEL
12	703264	1	DECAL
13	706149	4	MOUNT-VIBRATION
14	704183	1	GAUGE-FUEL
15	706150	1	WIRE
16	189134GS	4	GROMMET, Rubber
17	709662	1	BRACKET
18	791745	1	LINE, Fuel -(Cut to Fit)
19	209417GS	1	VALVE, Fuel
20	709655	1	HEATSHIELD
21	709660	1	HEATSHIELD
22	709665	1	MUFFLER
23	706152	1	SCREW, M6 x 12
24	67989GS	8	NUT, M8 Flange Serrated
25	49813GS	1	NUT, Hex, M6 - 1.0
26	22097GS	2	WASHER, Lock, Split, 1/4"
27	49811GS	2	WASHER
28	45771GS	1	NUT, M8 - 1.25
29	709664	1	GASKET, Muffler Adapter
30	84002343	1	DECAL
31	312909GS	2	SCREW
32	703191	1	COVER-REAR BEARING
33	709666	1	VOLTAGE REGULATOR
34	703075	1	TERMINAL BLOCK
35	706918	4	BOLT
36	707155	1	BOLT
37	703113	1	BRUSH ASSY
38	703454	1	LOCKWASHER, Spring, 3/8
39	84001095	1	BOLT
40	703190	1	CARRIER-BEARING
41	84003181	1	STATOR
42	709670	1	ROTOR
43	83083GS	1	SCREEN, Spark Arrest
44	189295GS	1	Washer, .432 x 1 x .064
45	26850GS	1	WASHER, Ext. M6 - 1/4" Shakeproof
46	189156GS	1	HHCS, M6-1.0 x 25
47	87680GS	1	NUT, M6 - 1.0 Wing

### Footnotes:

(Note:\* Verify your specific engine model, reference the ID Tag located on your engine.) (Refer to your local Briggs & Stratton distributor for parts and service.)

## Main Unit

REF NO	PART NO	QTY	DESCRIPTION
48	709661	1	BRACKET-MUFFLER
49	706165	1	WIRE
50	801237	1	WASHER
51	709657	1	BAND-STATOR
52	319587GS	1	CAP-FUEL
53	312005GS	4	WASHER
54	315017GS	1	HOSE, Vapor (cut to fit) -(Cut to Fit)
55	314955GS	1	CLAMP
56	703805	4	SCREW
57	709684	1	CARBON CANISTER
58	318884GS	1	BRACKET
59	84001097	1	DECAL
60	312908GS	2	SCREW
900	13U132-0003-G1	1	Engine -*(See Note:)

Not For  
Reproduction

---

**Footnotes:**

(Note:\* Verify your specific engine model, reference the ID Tag located on your engine.) (Refer to your local Briggs & Stratton distributor for parts and service.)

# Wheel Kit (80017980)

Note: Unless noted otherwise, use the standard torque specifications

Mfg. No: 030743-01

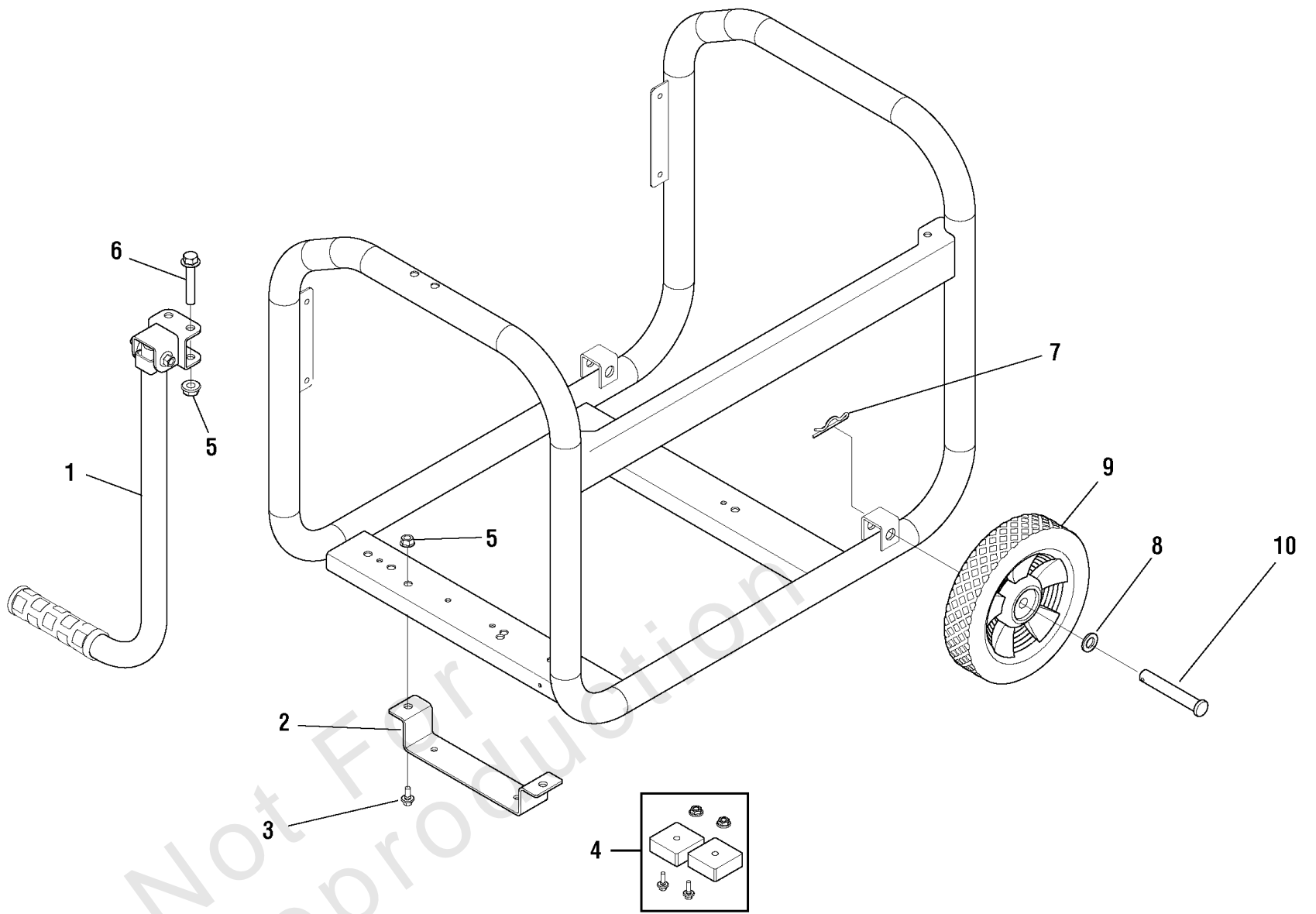

## Wheel Kit (80017980)

REF NO	PART NO	QTY	DESCRIPTION
1	709676		HANDLE
2	709677		SUPPORT-LEG
3	-----		* BOLT, M8-1.25 x 16
4	319285GS		MOUNT-VIBRATION
5	-----		* NUT, Flange, M8
6	-----		* BOLT, M8 x 80
7	316510GS		PIN-HAIR
8	318034GS		WASHER
9	318032GS		WHEEL
10	318035GS		AXLE
--	707180		KIT-HARDWARE -(Not Illustrated)

Not For  
Reproduction

---

**Footnotes:**

\* Items without part numbers are common fasteners. Purchase locally.



