

3 611 J03 R10

Issue } 10-05-12 **Fig./Abb. 1**
Stand }

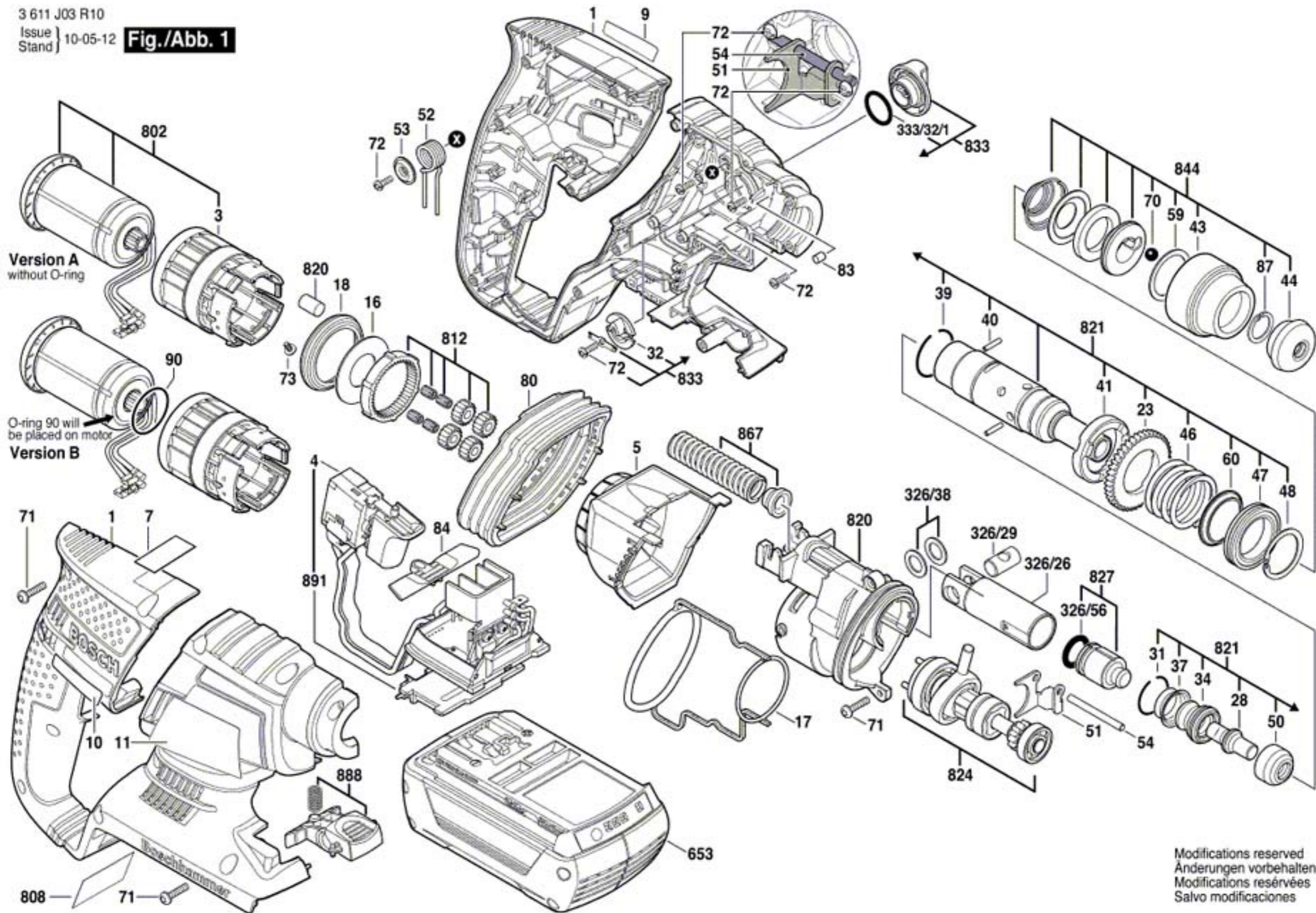

Modifications reserved
Änderungen vorbehalten
Modifications réservées
Salvo modificaciones

