

F 012 156 000

Stand } 07-07-24  
Issue }

**Fig./Abb. 1**

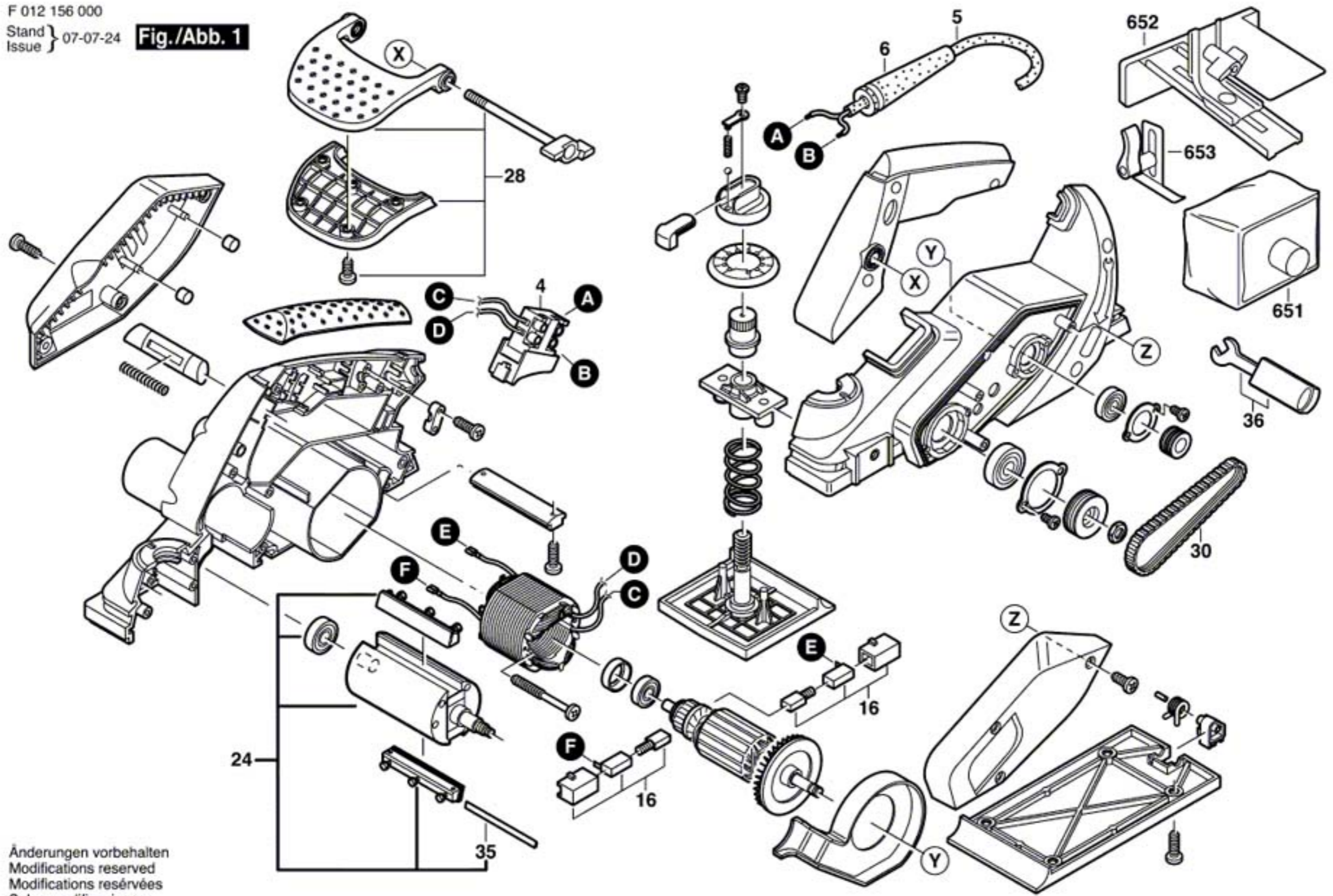

Änderungen vorbehalten  
Modifications reserved  
Modifications réservées  
Salvo modificaciones