

0 601 606 360

Issue } 00-07-10 **Fig./Abb. 1**
Stand }

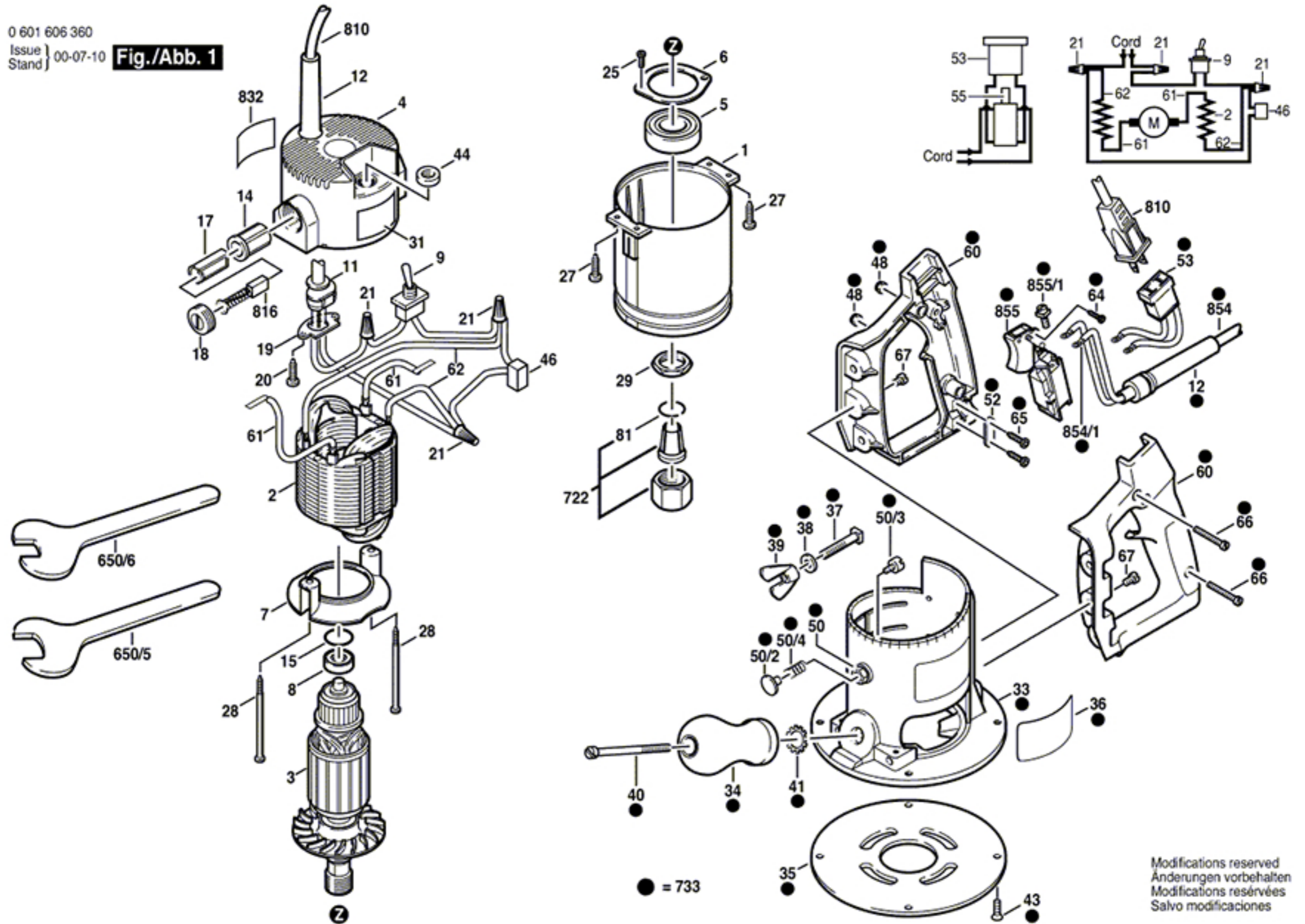

Modifications reserved
Änderungen vorbehalten
Modifications réservées
Salvo modificaciones