

0 601 617 139

Issue } 06-03-03
Stand }

Fig./Abb. 1

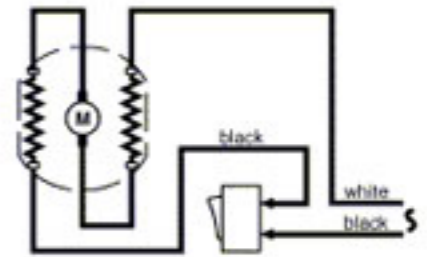
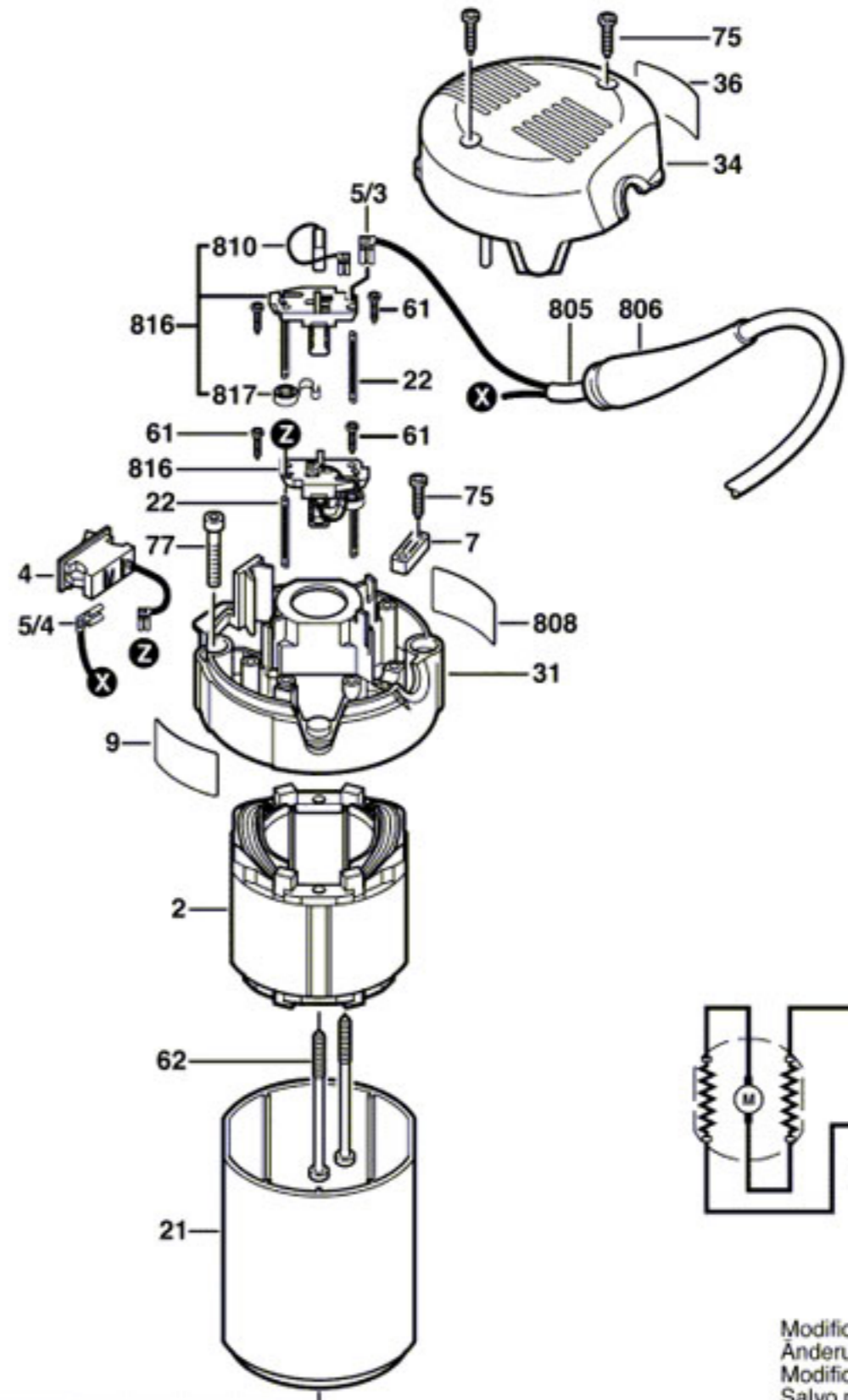
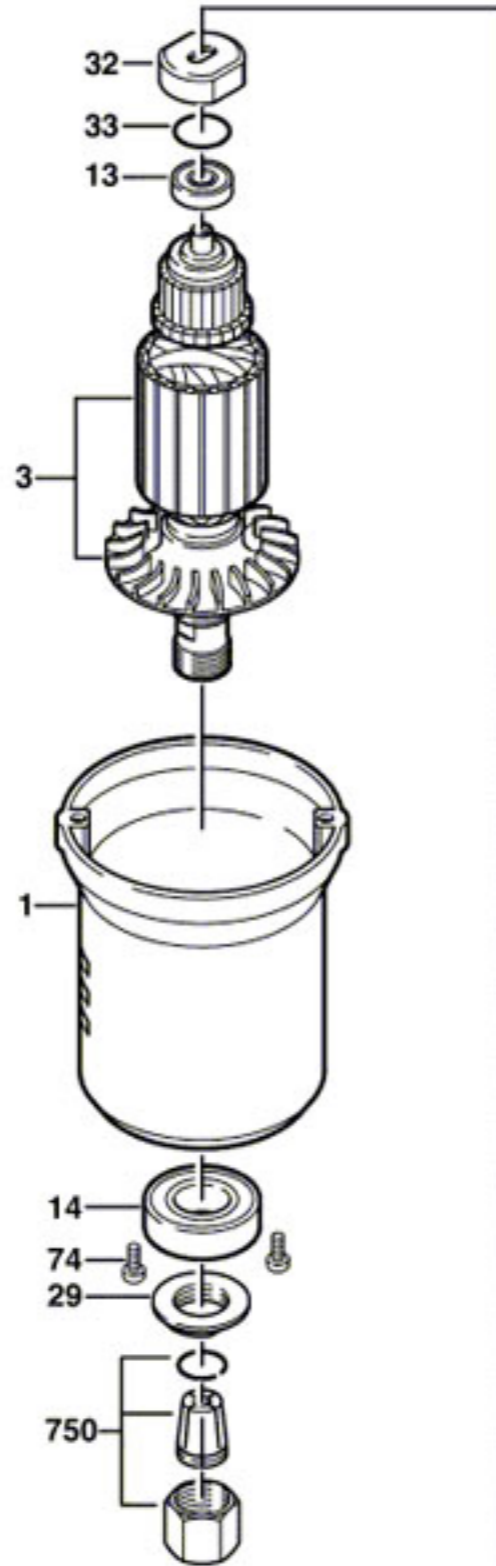
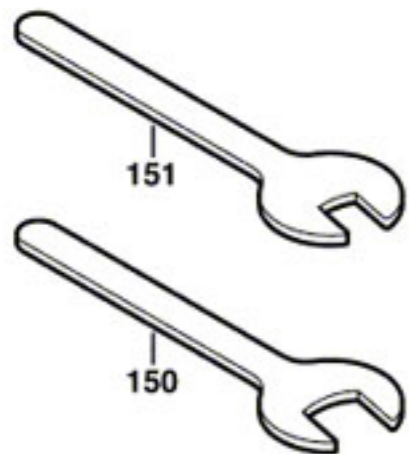

Modifications reserved
Änderungen vorbehalten
Modifications réservées
Salvo modificaciones