

0 601 617 739

Issue } 04-09-15 **Fig./Abb. 1**  
 Stand }

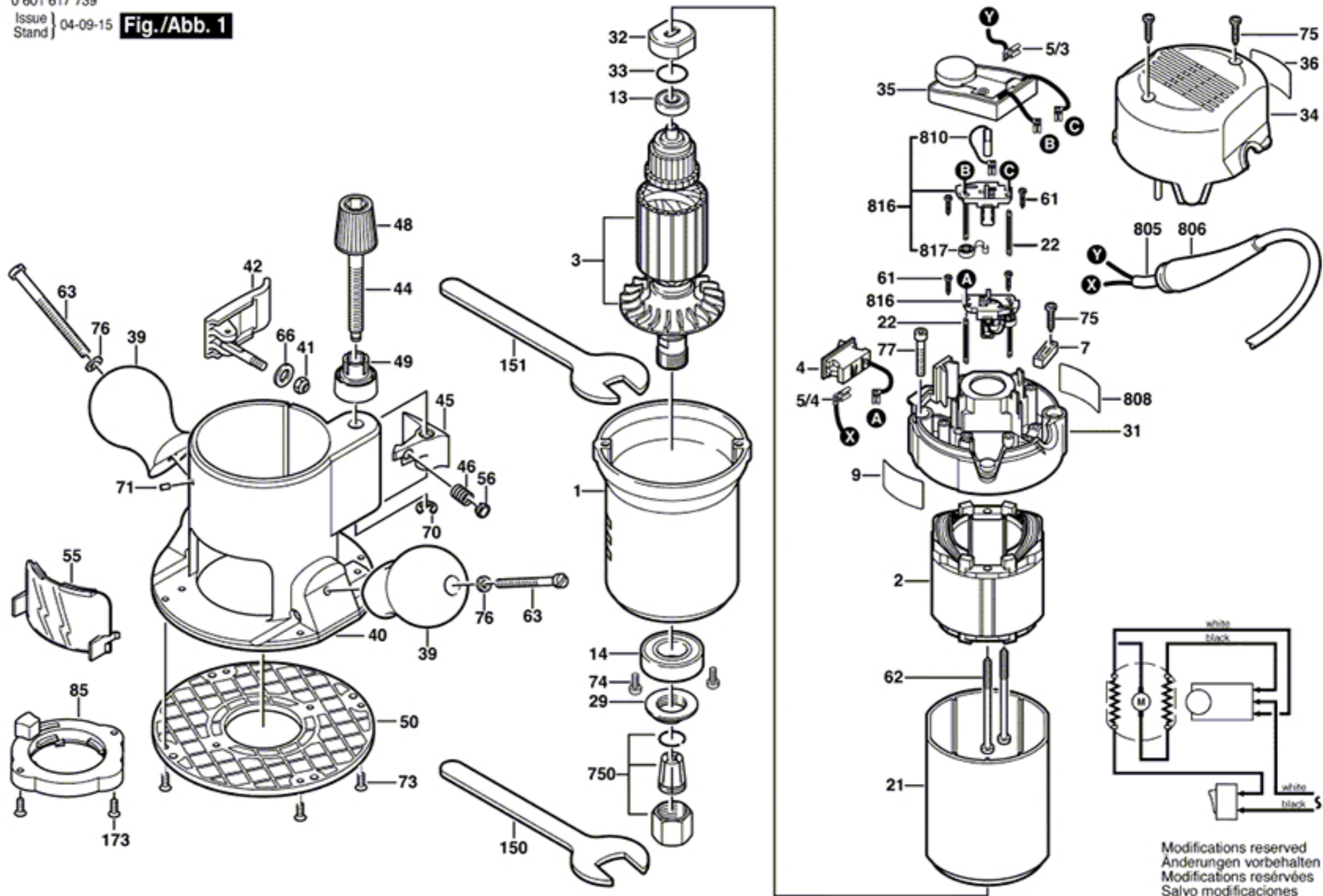

Modifications reserved  
 Änderungen vorbehalten  
 Modifications réservées  
 Salvo modificaciones