

F012281001

Issue } 05-05-26
Stand }

Fig./Abb. 1

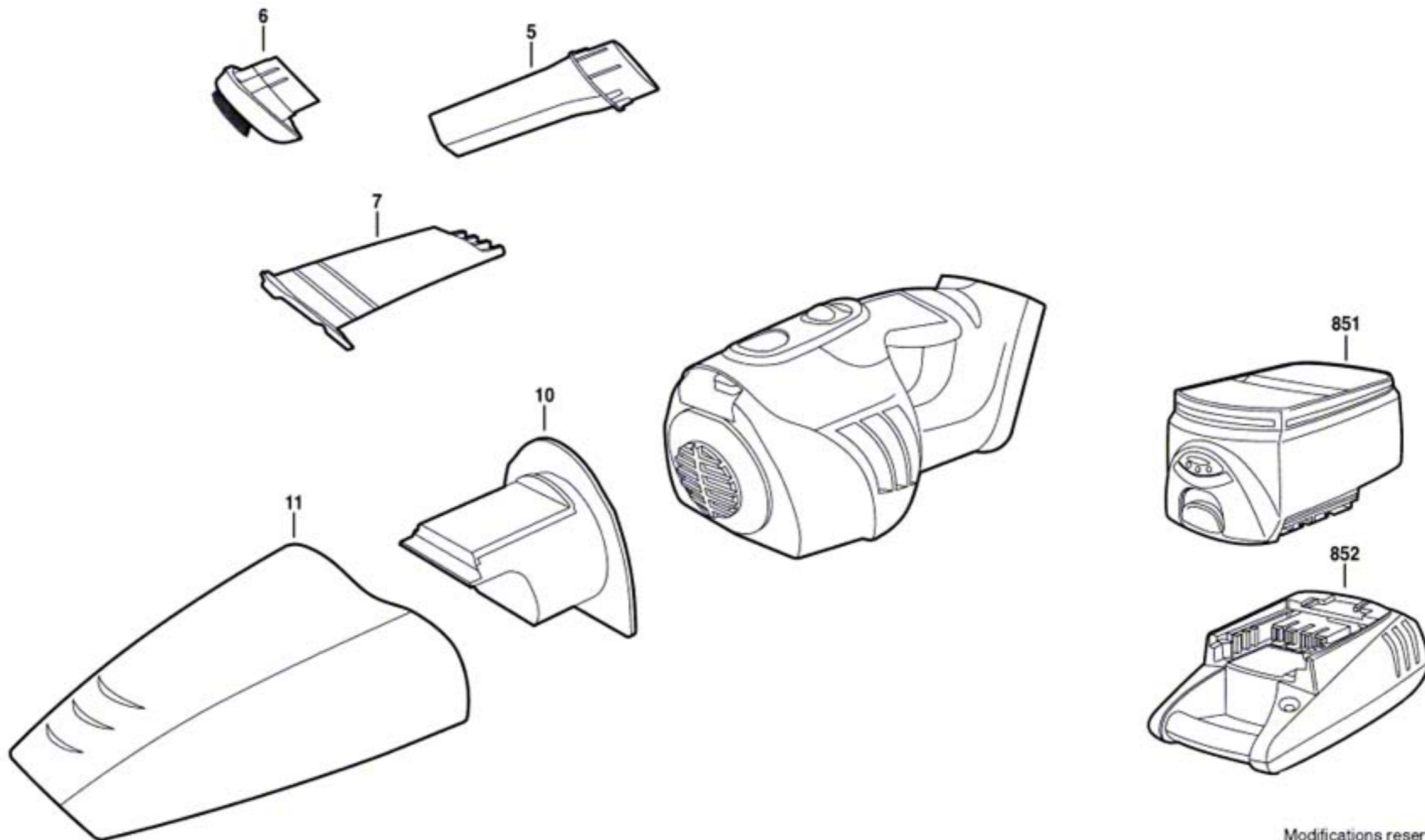

Modifications reserved
Änderungen vorbehalten
Modifications réservés
Salvo modificaciones