

0 603 310 639

Stand } 07-11
Issue } 11-05-26

Fig. /Abb. 1

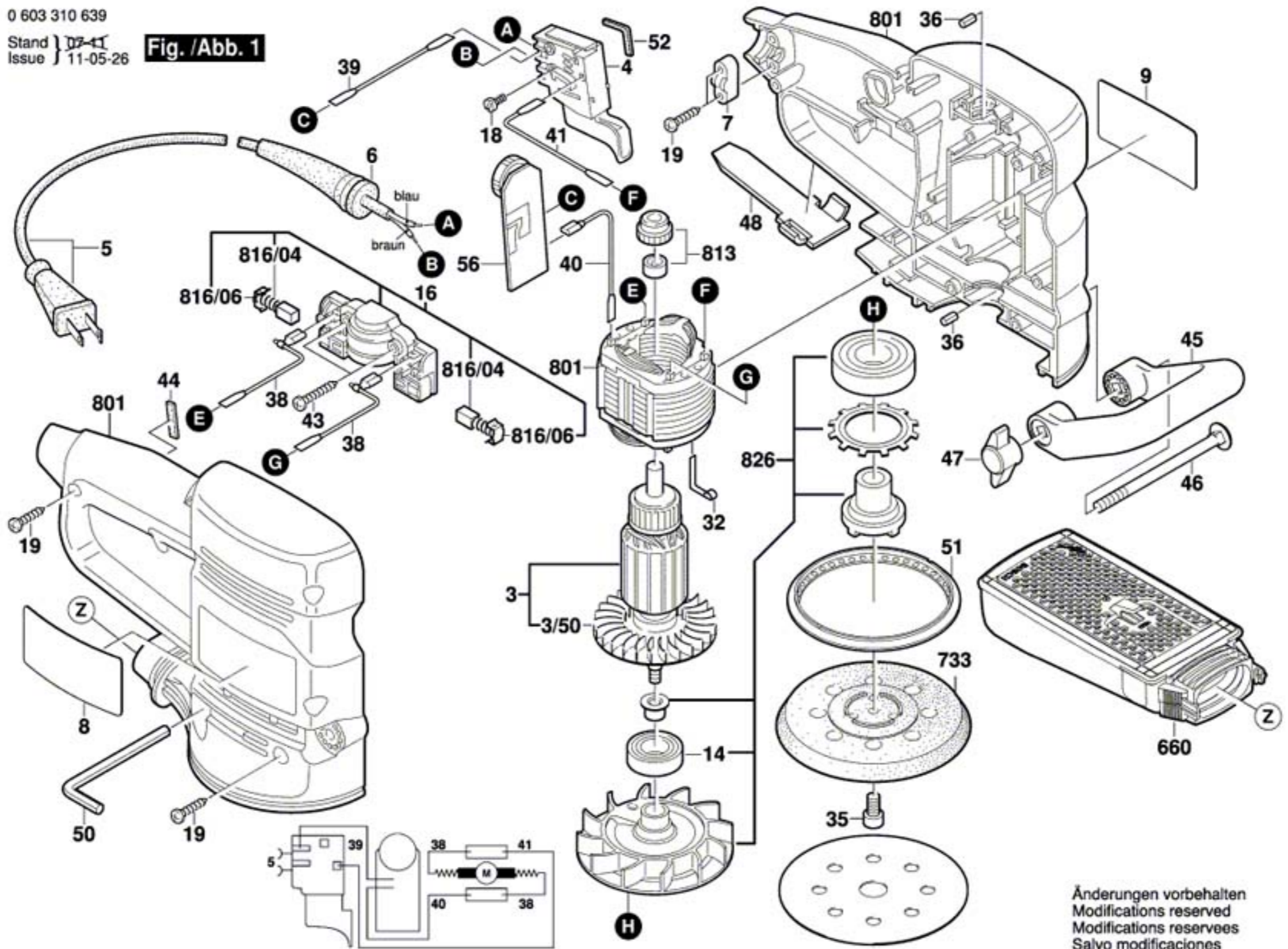

Änderungen vorbehalten
Modifications reserved
Modifications reserves
Salvo modificaciones