



# Pneumatic Hammer

#505900, JAT-900

#505901, JAT-901

#505902, JAT-902



JAT-901 shown

## Operation & Parts Manual

M-505900

Edition 3

11/2018



Stock No.:
Serial No.:
Purchased from:
Date purchased:

**JET**  
427 New Sanford Road  
LaVergne, TN 37086  
Ph.: 800-274-6848  
[www.jettools.com](http://www.jettools.com)

Copyright © 2015 JET

# #505902, JAT-902 Pneumatic Hammer – parts breakdown

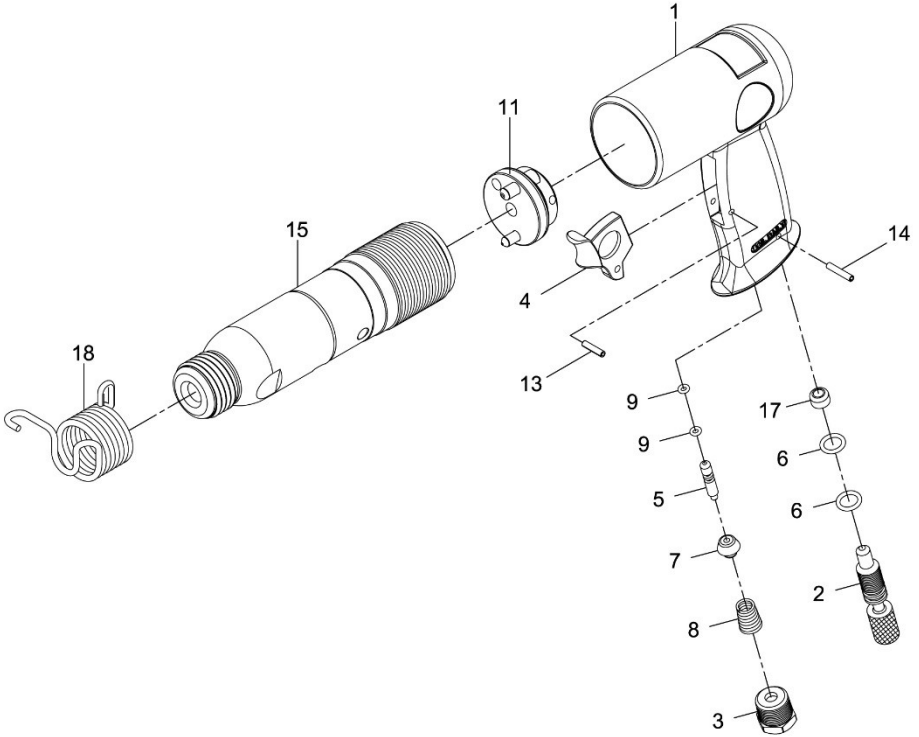

Index	Part No.	Description	Qty
1	JAT901-01	Housing	1
2	AH-18	Regulator	1
3	AH-4	Hose adaptor	1
4	AH-8	Trigger	1
5	AH-6X	Throttle valve stem 30.6mm	1
6	AH-17	O-Ring 7.8x1.9	2
7	AH-9	Steel ball seat	1
8	AH-5	Throttle spring	1

Index	Part No.	Description	Qty
9	AH-7	O-Ring 2x1.5	2
11	AH-10A	Valve assembly	1
13	AH-2X	Pin (for trigger) 3x14	1
14	AH-3X	Pin (for regulator) 3x16	1
15	AH-15-3A	Cylinder assembly (incl. piston)	1
17	AH-19	Valve seat	1
18	J0101S	Quick change spring retainer	1
	JSG-1304	Set of 4 chisels	1

RBK-0304R Rebuild Kit, contains 5,7,8,11,15