



BOSCH

Intermediate housing

550 WATT-SERIE | 0 607 452 609

Table of Content

Spare parts list.....	2
Illustration - Type.....	3

Illustration - Type - E

0 607 452 608; 609
Issue | 08-01-15
Stand | **Fig./Abb. 1**

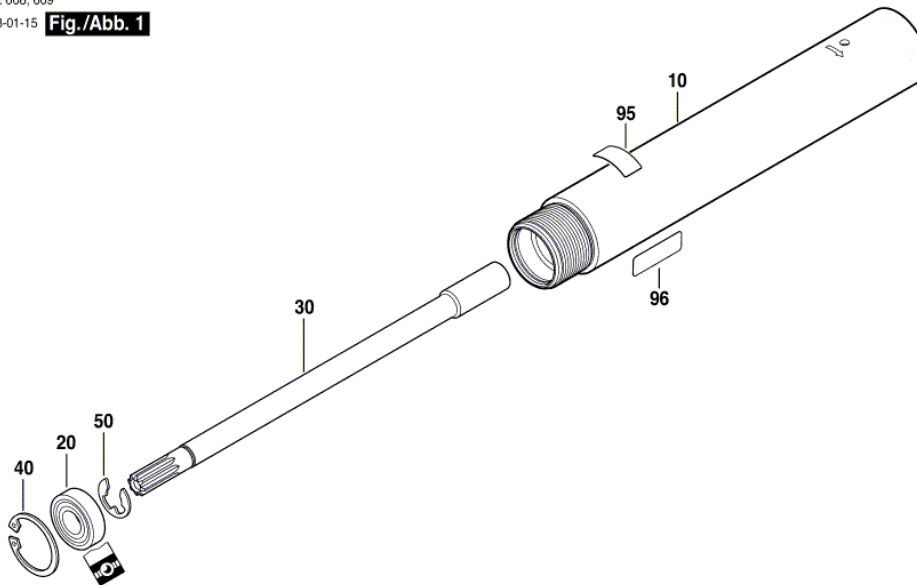

Änderungen vorbehalten
Modifications reserved
Modifications réservées
Salvo modificaciones