



SERVICE PARTS LIST

BULLETIN NO.
54-38-0752

SPECIFY CATALOG NO. AND SERIAL NO. WHEN ORDERING PARTS		REVISED BULLETIN 54-38-0751	DATE May 2005
7" GRINDER - 6000 R.P.M.			
CATALOG NO.	6068	STARTING SERIAL NO.	817B
		WIRING INSTRUCTION 58-01-1307	

EXAMPLE:

00 0 Component Parts (Small #) Are Included
When Ordering The Assembly (Large #)

★ = Part number change from previous service parts list.

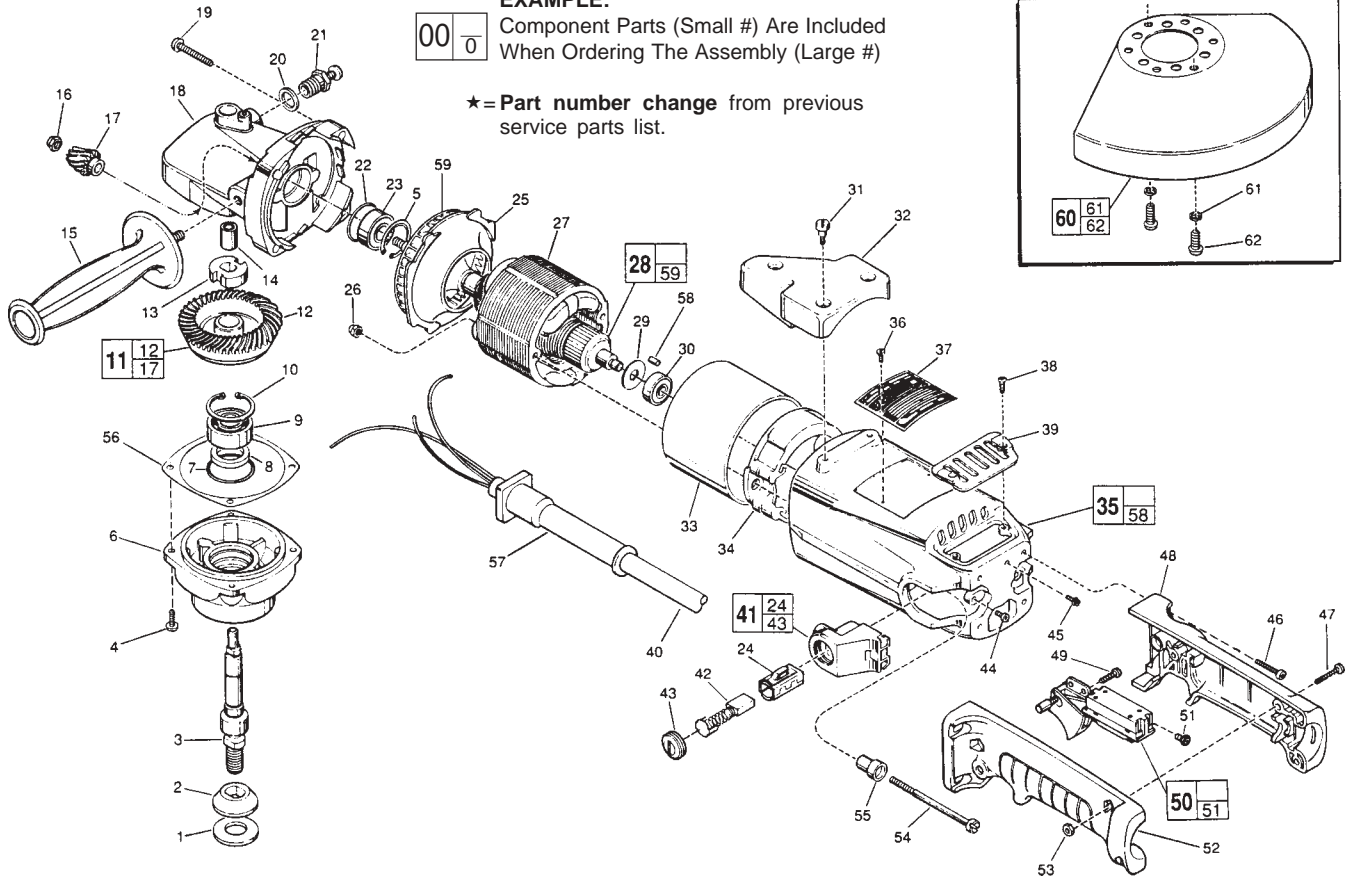

FIG.	PART NO.	DESCRIPTION OF PART	QTY.
1	45-88-8465	Spindle Washer	(1)
2	49-05-0060	Washer Flange	(1)
3	38-50-5560	Spindle Shaft	(1)
4	06-82-8880	10-24 x 5/8" Pan Hd. Taptite, T-25	(1)
5	34-80-2600	Internal Retaining Ring	(4)
6	28-14-1735	Lower Gear Case	(1)
7	34-40-1550	O-Ring	(1)
8	45-06-0330	Felt Seal	(1)
9	02-04-1745	Ball Bearing	(1)
10	34-80-2960	Retaining Ring - Internal	(1)
11	14-46-4300	Bevel Gear Kit	(1)
12	32-05-2201	Spiral Bevel Gear	(1)
13	42-74-0080	Spindle Locking Cog	(1)
14	02-50-2428	Needle Bearing	(1)
★ 15	43-62-1265	Side Handle	(1)
16	06-57-0500	1/4 - 28 Locking Hex Nut	(1)
17	32-60-1291	Spiral Bevel Pinion	(1)
18	28-14-2035	Upper Gear Case	(1)
19	06-82-5716	1/4-20 x 1-1/4" Pan Hd. Taptite, T-30	(4)
20	45-88-5320	Flat Washer	(1)
21	44-20-0235	Spindle Lock Assembly	(1)
22	34-40-1375	O-Ring	(1)
★ 23	02-04-1860	Ball Bearing	(1)
24	22-20-0360	Brush Tube	(2)
25	42-14-0300	Baffle	(1)
26	06-57-3005	10-32 Locking Hex Nut	(2)
27	18-70-0260	120 Volt Field	(1)
28	16-70-0300	120 Volt Armature	(1)
29	45-06-0390	Dust Seal	(1)
30	02-04-0913	Ball Bearing	(1)
31	45-04-0720	Shoulder Screw	(3)
32	31-70-0150	Tool Rest	(1)
33	23-16-0950	Insulating Sleeve	(1)
34	31-55-0110	Coil Shield	(1)
35	28-50-6351	Motor Housing	(1)
36	06-82-5270	6-32 x 1/4" Pan Hd. Taptite, T-15	(2)
37	12-99-0407	Nameplate Blank	(1)
38	06-82-3792	8-32 x 3/8" Flat Hd. Taptite, T-15	(2)

FIG.	PART NO.	DESCRIPTION OF PART	QTY.
39	31-15-0310	Cover Plate	(1)
40	22-64-3000	Cord Set	(1)
41	22-22-0401	Brush Holder Assembly	(2)
42	22-18-0730	Carbon Brush Assembly	(2)
43	23-44-0170	Brush Retaining Cap	(2)
44	06-82-7252	8-32 x 3/8" Pan Hd. T-20	(2)
45	06-95-5200	8-32 x 5/16" Slot Hex Hd. Screw	(1)
46	06-82-5574	10-24 x 7/8" Pan Hd. Taptite, T-25	(4)
47	06-82-2378	10-24 x 1" Pan Hd. T-25	(3)
48	31-44-0606	Right Handle Half	(1)
49	06-82-7409	8-16 x 1/2" Pan Hd. Plastite, T-20	(1)
★ 50	23-66-1798	Switch	(1)
★ 51	05-78-0305	M 3.5 Switch Screw, T-15	(2)
52	31-44-0607	Left Handle Half	(1)
53	06-55-1050	10-24 Hex Nut	(3)
54	06-82-9600	10-32 x 3-3/16" Field Screw, T-25	(2)
55	31-86-0160	Insulating Bushing	(2)
56	45-14-0225	Shim - Blue .005 Thick	(1)
	45-14-0210	Shim - Red .010 Thick	(1)
57	44-76-0170	Cord Protector	(1)
58	45-30-0070	Ball Bearing Retaining Slug	(1)
59	22-84-0800	Fan	(1)
60	49-12-0355	7" Wheel Guard Assembly	(1)
61	06-97-4000	1/4" Split Ring Lockwasher	(2)
62	06-95-5630	1/4-20 x 1/2" Special Screw	(2)

FIG. NOTES
13 Dimple Side To Fig. 12.
56 As Required (Max. .015").
4 Apply type 242 Blue Loctite to threads.

FIG. LUBRICATION
★ 18 **Important!** Completely clean out old grease from the upper gearcase and replace with 2 Oz. Type "Y" Grease, No. 49-08-5270.