

HUSQVARNA ROTARY LAWN MOWER - MODEL NO. 7021P (96133000708) - PRODUCT NO. 961 33 00-07

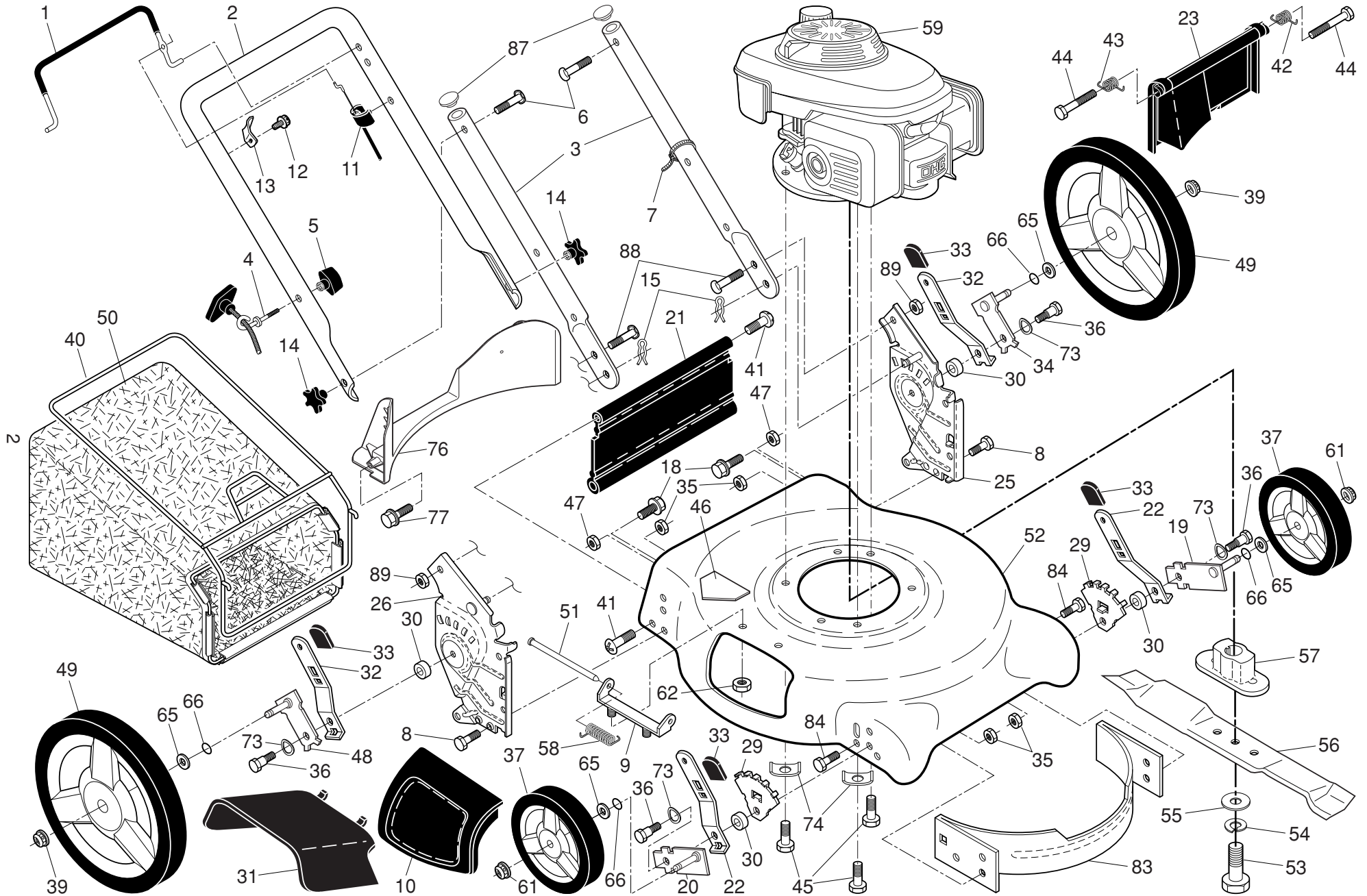

HUSQVARNA ROTARY LAWN MOWER - MODEL NO. 7021P (96133000708) - PRODUCT NO. 961 33 00-07

KEY NO.	PART NO.	DESCRIPTION	KEY NO.	PART NO.	DESCRIPTION
1	581 49 74-02	Control Bar, Overmolded	42	532 40 54-21	Spring, Rear Door, LH
2	532 42 79-71	Upper Handle	43	532 40 54-23	Spring, Rear Door, RH
3	580 63 86-03	Bar, Lower Handle	44	532 18 41-93	Bolt, Rear Door
4	581 90 21-01	Rope Guide	45	532 15 04-06	Hex Head Thread Rolling Screw 3/8-16 x 1
5	581 91 26-01	T-Knob	46	532 40 47-63	Danger Decal
6	532 19 15-74	Handle Bolt	47	532 75 11-53	Locknut, Hex 5/16-18
7	532 06 64-26	Wire Tie	48	532 41 06-01	Axle Arm Assembly, Rear, RH
8	874 78 05-12	Hex Bolt 5/16-18 x 3/4	49	580 33 46-01	Wheel & Tire Assembly, Rear 12 x 1-3/4
9	532 15 41-32	Hinge Bracket Assembly	50	581 00 21-12	Grassbag
10	581 82 58-01	Mulcher Door	51	532 14 72-86	Hinge Rod
11	532 40 80-47	Engine Zone Control Cable	52	532 44 19-50	Kit, Lawn Mower Housing Assembly (Includes Key Number 46)
12	532 17 88-48	Hex Washer Head Screw #10-16 x 5/8	53	532 85 10-84	Hex Head Screw 3/8-24 x 1-3/8 Grade 8
13	532 43 00-34	Up-Stop Bracket	54	532 85 02-63	Helical Lockwasher
14	532 18 23-98	Handle Knob	55	532 85 10-74	Hardened Washer
15	532 05 17-93	Hairpin Cotter	56	532 40 67-12	21" Blade
18	817 60 04-06	Screw 1/4-20 x 3/8	57	532 41 83 73	Blade Adapter
19	532 40 66-89	Axle Arm Assembly, Front, LH	58	532 15 21-24	Spring, Torsion
20	532 40 66-90	Axle Arm Assembly, Front, RH	59	- - -	Engine, Honda, Model Number GCV160-LAOS3B (Order parts from engine manufacturer)
21	532 41 86-55	Kit, Rear Skirt	61	532 40 91-48	Nut, Hex, Flangelock
22	532 40 64-28	Selector Spring, Front	62	873 80 04-00	Nut, Hex, Nylock 1/4-20
23	581 42 56-01	Rear Door Assembly	65	532 08 83-48	Washer, Flat
25	580 91 56-03	Handle Bracket Assembly, LH	66	532 19 74-80	O-Ring
26	580 91 57-03	Handle Bracket Assembly, RH	73	532 40 16-30	Washer, Flat
29	532 41 05-94	Wheel Adjusting Bracket, Front	74	532 12 50-78	Washer, Special, Engine, Zinc-Plated
30	532 40 16-29	Spacer	76	532 41 05-89	Baffle, Rear
31	532 18 55-95	Discharge Deflector	77	817 41 13-12	Screw, Rear Baffle
32	532 44 15-59	Selector Spring, Rear	83	532 42 85-01	Baffle, Front
33	532 08 78-77	Selector Knob	84	817 00 05-10	Screw, Hex Head 5/16-18
34	532 41 06-00	Axle Arm Assembly, Rear, LH	87	532 43 75-16	Plug, Handle Bar
35	532 42 65-89	Locknut, Hex 5/16-18	88	872 25 05-05	Bolt, Carriage
36	532 40 16-38	Shoulder Bolt 5/16-18	89	873 97 05-00	Nut, Hex
37	532 41 08-31	Wheel & Tire Assembly, Front 8 x 1-3/4	--	532 40 47-64	Warning Decal (not shown)
39	532 40 91-49	Nut, Hex, Flangelock	--	115 63 39-32	Operator's Manual, English / French
40	532 41 19-49	Frame, Grassbag			
41	532 19 41-86	Hinge Screw			

NOTE: All component dimensions given in U.S. inches. 1 inch = 25.4 mm. **IMPORTANT:** Use only Original Equipment Manufacturer (O.E.M.) replacement parts. Failure to do so could be hazardous, damage your lawn mower and void your warranty.