

Type: ASW 18-12 PC (12-18V)

Part no.: 71126800940

Item	Part no.	Designation	Quantity
10	31901197010	Motor housing	1
11	32424025004	Cover	1
12	30501352000	Sleeve	1
30	33101013010	Rotor Z=10	1
35	30762623990	Electronics	1
45	30109196990	Gearbox	1
70	32436080000	Flange	1
71	32601279000	Ring	1
75	30509048000	Thread ring	1
95	30762526990	Electronics	1
100	30719933010	Cable harness	1
110	30701310010	Toggle switch	1
120	32804002010	Slide switch	1
121	30901370000	Spiral spring	1
130	42615000002	Circlip	1
200	43072015000	Screw	11
315	51113017800	Stator	1
320	41701000012	Grooved ball bearing	2
330	33605011000	Gear-wheel	1
510	32436079000	Flange	1
520	41701108222	Grooved ball bearing	1
605	30104144060	Clutch	1
610	30104152000	Tool holder	1
620	30103052000	Clutch ring	1

Type: ASW 18-12 PC (12-18V)
Part no.: 71126800940

Item	Part no.	Designation	Quantity
630	30102108000	Clutch ring	1
640	41708018000	Ball	9
650	41708017002	Ball	9
660	30901372000	Spiral spring	1
675	32602092010	Pressure piece Set	1
690	42615110009	Circlip	1
910	31201148000	Cover	1
925	30762527990	Electronics	1
2500	32217517000	RFID Transponder VE1	1
5011	42615000004	Circlip	1
5020	30216171020	Bolt	1
5021	30216171000	Bolt	1
5022	30901410000	Spiral spring	1
5023	30218037000	Plug	1
5030	30217340015	Bolt	1
5031	30901360009	pressure spring	1
5032	30217340006	Bolt	1
5040	30102109010	Tool holder Set	1
5041	41708015005	Ball	1
5042	30503144002	Sleeve	1
5043	30901315002	Spiral spring	1
5044	32601242005	Ring	1
5045	42615081002	Circlip	1

Type:
Part no.:

ASW 18-12 PC (12-18V)
71126800940

7 112 65 - ASW 18-6
7 112 66 - ASW 18-6 PC
7 112 67 - ASW 18-12
7 112 68 - ASW 18-12 PC

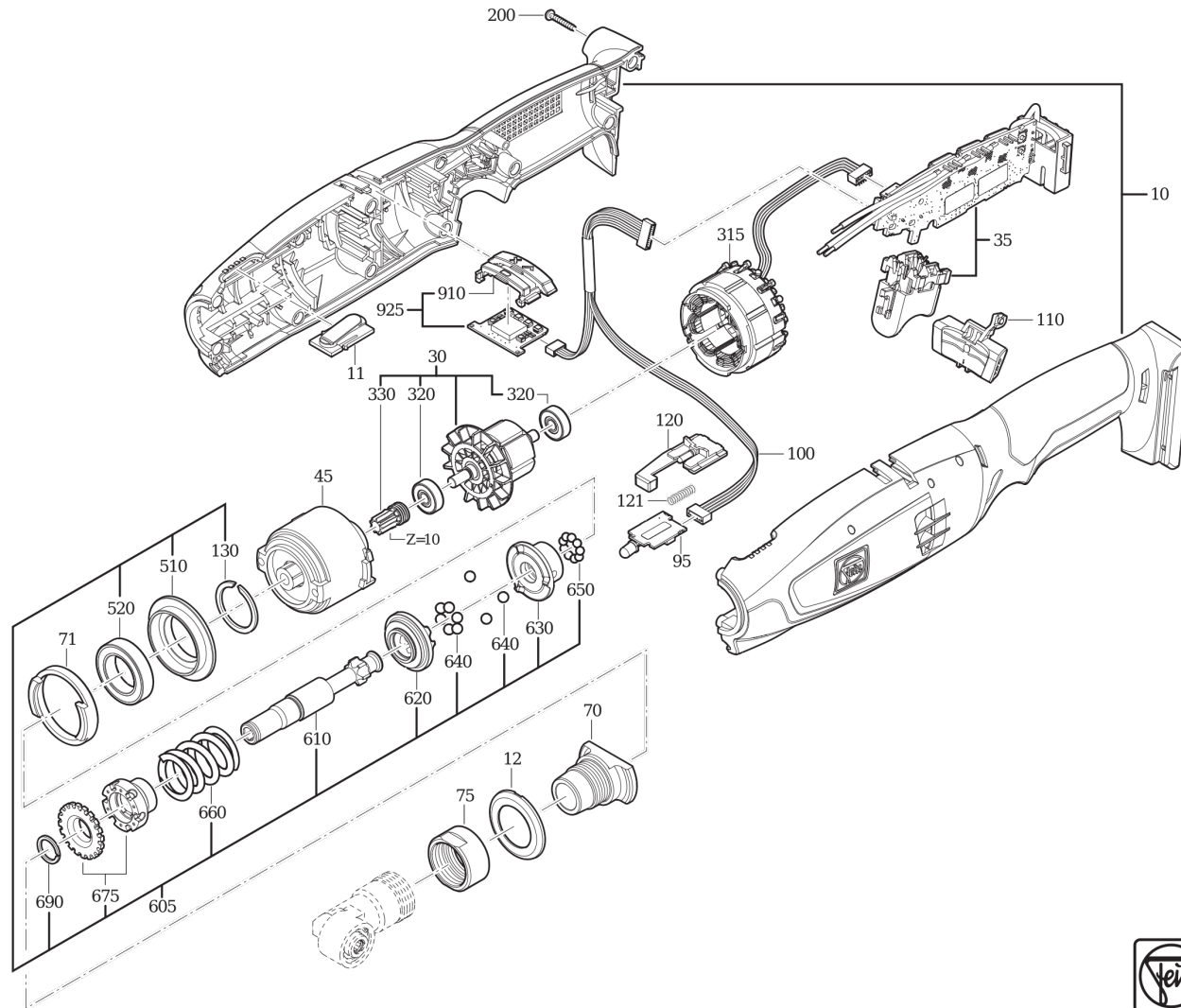

Type:
Part no.:

ASW 18-12 PC (12-18V)
71126800940

7 112 65 - ASW B-6
7 112 66 - ASW B-6 R
7 112 67 - ASW B-12
7 112 68 - ASW B-12 R

