

Type: ABH 18
Part no.: 71400200940

Item	Part no.	Designation	Quantity
10	31348000001	Protective cap	1
20	31348000002	Cover	1
30	31348000003	Circlip	1
40	31348000004	Disc	1
50	31348000005	Ball	1
60	31348000006	Covering plate	1
70	31348000007	Spring	1
80	31348000008	Screw	4
90	31348000009	Spring	1
100	31348000010	Plate	1
110	31348000011	Sealing ring	1
120	31348000012	Striking body	1
130	31348000013	Sealing ring	1
140	31348000014	Piston	1
150	31348000015	Bolt	1
160	31348000016	Disc	2
170	31348000017	Screw	2
180	31348000018	Plate	1
190	31348000019	Sealing ring	1
200	31348000020	Circlip	1
210	31348000021	Pinion	1
220	31348000022	Spring	1
230	31348000023	Disc	1
240	31348000024	Cover	1

Type: ABH 18
Part no.: 71400200940

Item	Part no.	Designation	Quantity
250	31348000025	Housing	1
260	31348000026	Felt ring	1
270	31348000027	Disc	1
280	31348000028	Sealing ring	1
290	31348000029	Bush	1
300	31348000030	Pressure piece	1
310	31348000031	Grooved ball bearing	1
320	31348000032	Plate	1
330	31348000033	Screw	2
340	31348000034	Rotor	1
350	31348000035	Grooved ball bearing	1
360	31348000036	Screw	2
370	31348000037	Holder	1
380	31348000038	Stator	1
390	31348000039	Toggle switch	1
400	31348000041	Screw	9
430	31348000043	Information sign	1
440	31348000044	Screw	2
450	31348137010	Handle	1
460	31348000046	Motor housing	1
470	31348000047	Gearbox housing Set	1
480	31348000048	Switch pushbutton	1
490	31348000049	Electronics with switch	1
500	31348000050	Clutch Set	1

Type: ABH 18
Part no.: 71400200940

Item	Part no.	Designation	Quantity
510	31348000051	Striking body	1
5000	33901146190	Tool case	1
5200	32119122000	Handle	1
5210	30232050000	Wire clamp	2
5300	33904593000	Case insert	1
6000	31348000052	Lubricant can 0,1 Kg	1

Type:
Part no.:

ABH 18
71400200940

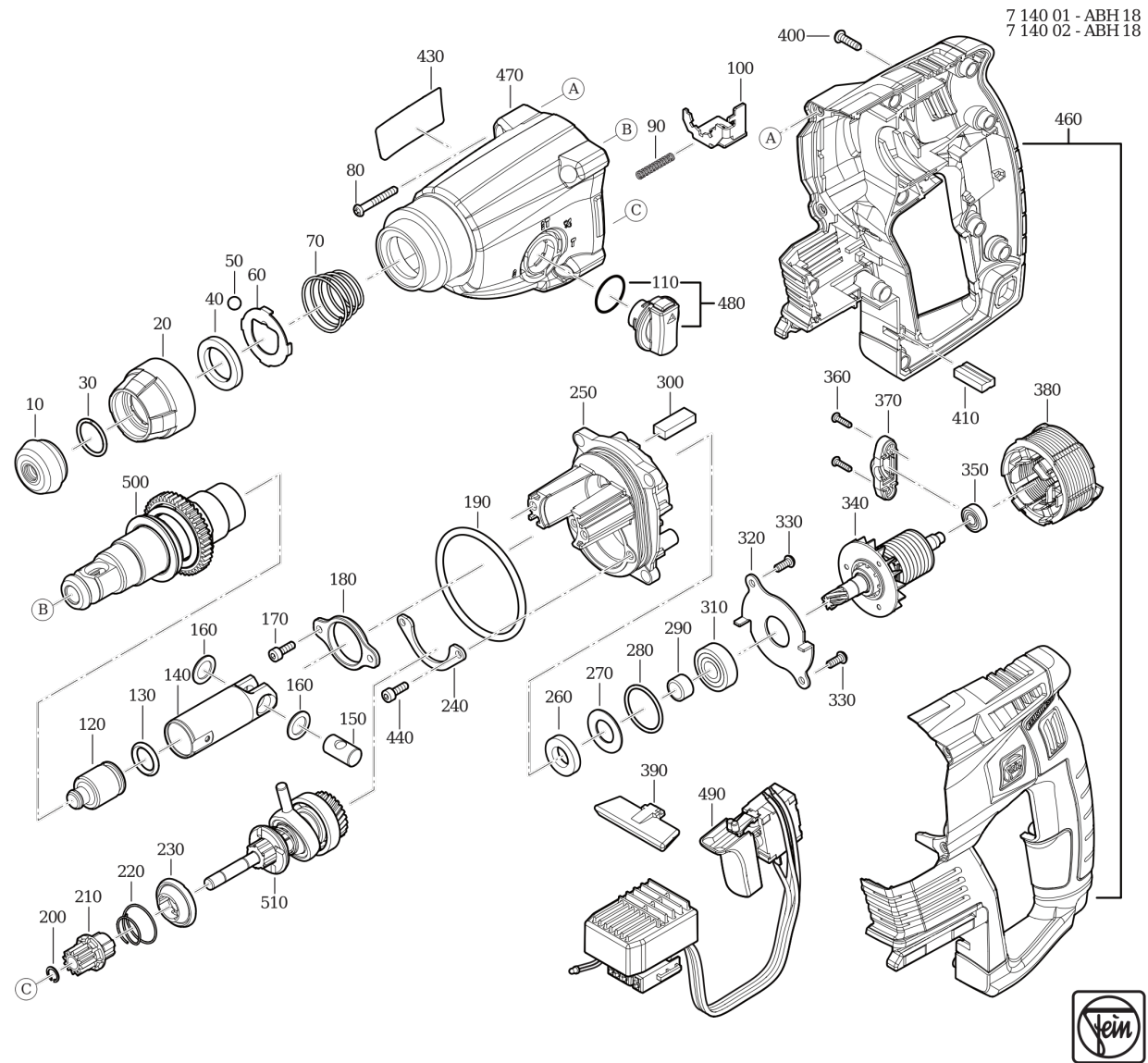

Type:
Part no.:

ABH 18
71400200940

7 140 01 - ABH 18
7 140 02 - ABH 18

