

The picture shown is for reference only. It may differ from actual unit.

85 Torque 7-10 Ft-Lbs

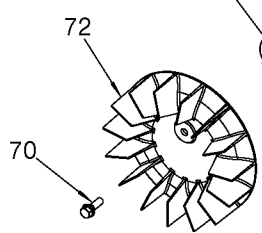
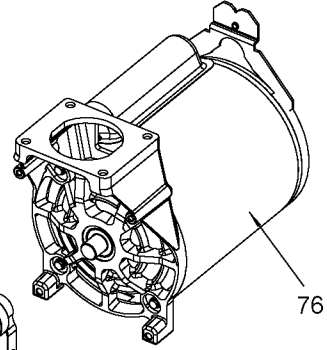
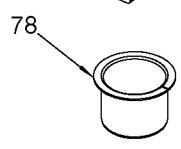
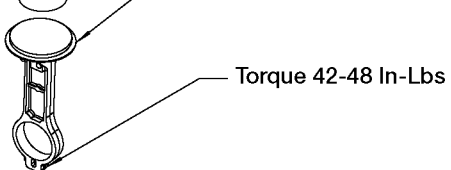
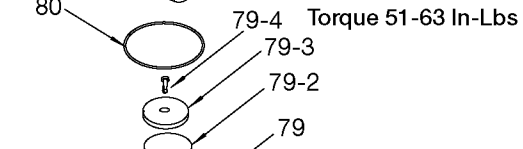
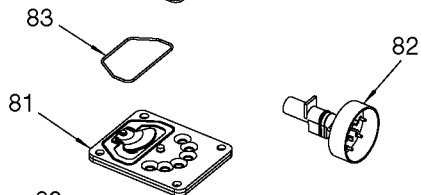
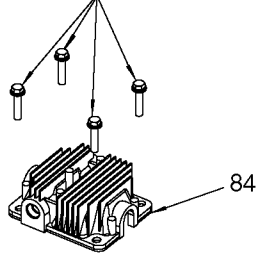

Torque 100-120 In-Lbs

73 Torque 100-120 In-Lbs

## Parts List for 919-16553 Type 1

Item Number	Part Number	Description	Qty Required
1	ACG-408	ASSY FASTENER	3
2	N176201	SHROUD KIT	1
3	91895680	SCREW .250-20X.750 H	2
4	ACG-18	CUP SADDLE MOUNT	2
5	CAC-1373	BUSHING FILTER RETAI	1
6	D24235	FILTER KIT	1
7	5140118-36	GRIP .875 DIA	1
8	AC-0609	HANDLE P/L PAINTED	1
9	SSP-6021	BUSHING REDUCER 1/8-	1
11	Z-D27212	GAUGE 200PSI .125NPT	1
14	5140117-89	PRESSURE SWITCH	1
15	D20114	VALVE SAFETY 175 .25	1
17	D26615	CORD POWER ST 14GA 1	1
19	D24888	NIPPLE .25NPT X 2.5	1
20	N053094	NIPPLE	1
21	AC-0630	TUBE PRESSURE RELIEF	1
22	N008792	REGULATOR RPR KIT	1
22	D27253	REGULATOR 4PORT P2 L	1
23	A19513	BODY QC .250 IND .25	1
24	N286039	DRAIN VALVE	1
26	SSP-7811	ASSY NUT SLEEVE 1/4	2
27	A19712	VALVE CHECK 1/2NPT X	1
28	D21172	SCREW .250-20X.500 H	1
30	N176201	SHROUD KIT	1
30	000000-00	No Longer Available	1
31	SSP-7813	ASSY NUT SLEEVE 3/8	1
32	AC-0774	ISOLATOR 3PT MOUNT 6	3

## Parts List for 919-16553 Type 1

Item Number	Part Number	Description	Qty Required
33	AC-0292	TUBE OUTLET .375OD	1
34	SSP-7821-1	NUT .563-18 UNF HEX	1
35	SSG-3105	ORING 306/296ID 073/	1
36	000000-00	No Longer Available	1
45	LA-3069	LABEL CRAFTSMAN	1
46	LA-3027	LABEL DRAIN TANK ENG	1
47	LA-3108	LABEL HOT SURFACE EN	1
48	SST-107	BUMPER RECESSED RUBB	2
49	SSF-630	SCREW .250-20X1.50 H	2
50	A13282	LABEL APP DUTY SEARS	1
51	D23138	WHEEL 9 BLACK SEMI-P	2
52	CAC-60	BOLT .375-16X2.25 UN	2
53	SSF-8080-ZN	NUT .375-16 UNC-2B H	2
54	000000-00	No Longer Available	1
70	SSF-586	SCREW .250-20X.750 U	1
72	AC-0108	FAN 5.75 DIA	1
73	SSF-615	SCREW .250-20X1.25 U	1
74	Z-AC-0140	ASSY ECCENTRIC BEARI	1
76	000000-00	No Longer Available	1
78	KK-4835	KIT CONNECTING ROD L	1
79	KK-4835	KIT CONNECTING ROD L	1
79	CAC-248-2	RING COMPRESSION	1
79	ACG-29	CAP CONNECTING ROD C	1
79	SSF-3158-1	SCREW #10-24X.750 TH	1
80	SSG-8156	ORING 2.759/2.719ID	1
81	Z-AC-0032	ASSY VALVE PLATE	1
83	ACG-45	ORING P/L HEAD	1

## Parts List for 919-16553 Type 1

Item Number	Part Number	Description	Qty Required
84	AC-0037	HEAD 3/8 OUTLET FRON	1
85	SSF-927	SCREW .250-20X1.125	1
856	D21477	KIT START CAPACITOR	1
856	D29142	KIT START CAPACITOR	1
856	000000-00	No Longer Available	1
856	K-0650	KIT COMP RING REPLAC	1
856	KK-4835	KIT CONNECTING ROD L	1
856	D23936	KIT START CAP GE	1