

***** Tightening direction
 Sens de serrage
 Sentido de apriete
 Anziehrichtung
 Senso di serraggio
 Sentido de aperto
 Kiristyssuunta
 Åtdragningsriktning
 Tilstrammingsretning
 Tilspændingsretning
 Schroefrichting
 Φορά σύσφιξης
 上紧方向
 Meghúzás iránya
 Pievilkšanas virziens
 Kierunek dokręcania
 Směr utahování
 Smer zatesnjevanja
 Sukimo kryptis
 Направление затяжки

b) 50 / 32		60 Nm
b) 33 / 32		3 Nm
c) 20 / 25		2 Nm
a) 13 / 6		3 Nm
d) 1 / 32		30 Nm
46 / 41		30 Nm
38 / 25		30 Nm

- a) : "Loctite 222"
- b) : "Loctite 243"
- c) : "Loctite 641"
- d) : "Loctite 270"

	mm
H maxi	10.85
H mini	9.8

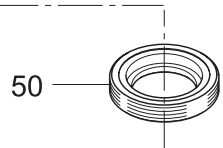
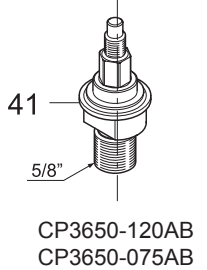

	rpm
CP3650-120AB	12000
CP3650-075AB	7500

Index No.	Parts No.	Description	Qty
1	6153967390	Adaptater	1
6	6154300330	Inlet	1
7	6156452290	Disc Spring	1
12	6155960040	Lever Bracket	1
18	6153967350	Safety lever	1
20	6154570490	Governor 19K (120AB)	1
20	6154570500	Governor 15K (075AB)	1
25	6154261200	Rotor	1
26	6154001480	Cylinder	1
41	6155011130	Shaft 5/8"	1
46	605.86	Nut	1
50	673.98	Plug	1
A	2050556023	Silencer Kit	1
2		Silencer	1
3		O-Ring	1
5		Valve	1
B	6153967360	Bushing Complete	1
14		Bushing	1
15		O-Ring	1
16		Pin	1
17		O-Ring	1
C	2050556033	Valve Kit	1
8		Spring Conical	1
9		Ball	1
10		Valve seat	1
11		O-Ring	1
D	2050556043	Rear Endplate Kit	1
21		Bearing	1
22		Rear Endplate	1
E	2050556063	Blades Kit	1
24		Blade	4
F	2050556053	Front Endplate Kit	1
27		Front Endplate	1
28		Plate Spacer	1
29		O-Ring	1
30		Bearing	1
G	6153933290	Housing Complete Kit 7500RPM	1
32		Housing	1
33	6153974060	Stopfinger Complete	1
53		Greaser	1
31		Insulator 7500RPM	1
37		External cover	1
51		Left side brand name plate	1
52	6158727900	Warning label	1
36		Cover	1
1		Adaptater	1
39	396.001	Grease Kit - 5g	1

Index No.	Parts No.	Description	Qty
G	6153933320	Housing Complete Kit 12000RPM	1
32		Housing	1
33		Stopfinger Complete	1
53		Greaser	1
31		Insulator 12000RPM	1
37		External cover	1
51		Left side brand name plate	1
52		Warning label	1
36		Cover	1
1		Adaptater	1
39	396.001	Grease Kit - 5g	1
H	399.480	Bevel Gear paired set (120AB)	1
38		Bevel gear	1
39		Grease Kit - 5g	1
H	6153971710	Bevel Gear paired set (075AB)	1
38		Bevel gear	1
39		Grease Kit - 5g	1
I	2050556083	Output Bearing Kit	1
40		Bearing	1
46		Nut	1
47		Deflector	1
48		Bearing	1
J	2050556073	Motor Bearing Kit	1
30		Bearing	1
21		Bearing	1
K	2050556013	Small parts kit	1
46		Nut	1
47		Deflector	1
23		Pin	1
19		Pin	1
4		Spring Cylindrical	1
L	2050556003	Tune Up Kit	1
	2050556063	Blade Kit	
3		O-ring	1
11		O-ring	1
15		O-ring	1
17		O-ring	1
29		O-ring	1

	2050554963	Operator's Manual
	2050554993	EC Declaration Sander
	6159948770	Safety Instructions Sanders

ACCESSORIES INCLUDED

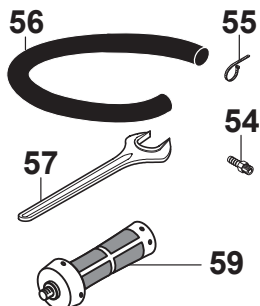

Item	Part no.	Description	Qty
54	6157040270	3/8" Air Hose Nipple for 1/2" (13mm) ID Hose	1
55	6152630240	Hose Clamp	2
56	6158751130	Exhaust Hose	1
57	6159951070	Spanner Wrench 17mm	1
59	6155760380	Vibration-damping Side Handle	1

OPTIONAL ACCESSORIES

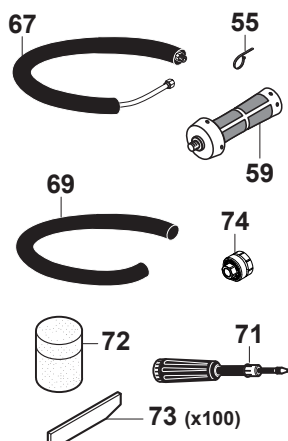

Item	Part no.	Description	Qty
55	6152630240	Hose Clamp	1
59	6155760660	Vibration-damping side handle	2
67	6153961660	Silencer Kit with Hose Clamp (55) (-11 dB)	1
69	6158751160	Reinforced Cloth-lined Exhaust Hose L=30"	1
71	6159901490	Grease Gun Included (24g)	1
72	6159901480	Grease for Bevel Gear (1kg)	1
73	6154340640	Blades Kit (x100)	1
74	6153969570	Clippable Silencer (-6 dB)	1

Dust extraction kit Ø5" (125mm) for composite (non metal and metal sanding)

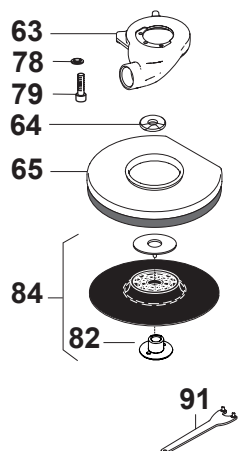

Item	Part no.	Description	Qty
	6153992800	Complete kit	1
63	6155041940	Suction Cap	1
64	6156430880	Spacer 15mm (5/8")	1
64	6156430870	Spacer 15mm (M14)	1
65	6155702340	Skirt with Brush 5"	1
78	6156451420	Washer	2
79	616.99	Screw	2
84	6159901270	Ventilated Backing Pad 5" with Nut M14 & 5/8" (82) (max. speed 12000rpm)	1
91	6158020670	Pin Wrench 1-3/8"	1
82	6156060450	Nut (5/8")	1
82	6156060460	Nut (M14)	1

OPTIONAL ACCESSORIES

Dust extraction kit for diamond disc Ø5" (125mm)

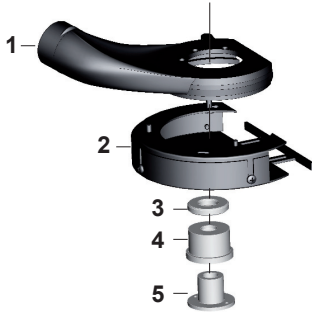

Item	Part no.	Description	Qty
	6153992810	Complete kit	1
1	6155042170	Manifold Cutting with screws	1
2	6155042180	Goble Cover Plate Complete	1
3	6156430920	Spacer 6mm - Hole 14mm	1
3	6156430910	Spacer 6mm - Hole 16mm	1
4	6156430890	Spacer for M14 spindle	1
4	6156430900	Spacer for 5/8" spindle	1
5	6156060460	Flange Nut M14	1
5	6156060450	Flange Nut 5/8"	1
.	6158020670	Pin Key	1

Semi-hard backing pad Ø5" (125mm) with nut M14 & 5/8"

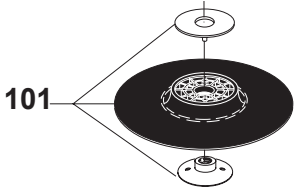

Item	Part no.	Description	Qty
101	6158040740	Semi-hard backing pad Ø5" (125mm) with nut M14 & 5/8" (max speed 12000rpm)	1

Dust extraction kit Ø7" (180mm) for composite (non metal and metal sanding)

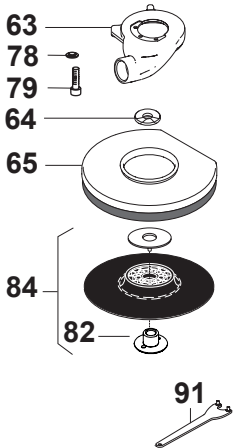

Item	Part no.	Description	Qty
	6153978290	Complete kit	1
63	6155041940	Suction Cap	1
64	6156430880	Spacer 15mm (5/8")	1
64	6156430870	Spacer 15mm (M14)	1
65	6155702310	Skirt with Brush 7"	1
78	6156451420	Washer	2
79	616.99	Screw	2
84	6159901340	Rigid Backing Pad 7" with nut M14 & 5/8" (82) (max. speed 8500rpm)	1
91	6158020670	Pin Wrench 1-3/8"	1
82	6156060450	Nut (5/8")	1
82	6156060460	Nut (M14)	1

Sanding guard Ø7" (180mm)

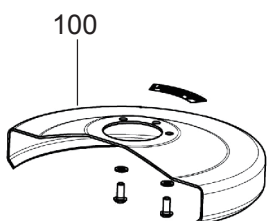

Item	Part no.	Description	Qty
100	6155042050	Sanding Guard 7" kit	1
		Screw Hex Button M5x12	2
		Washer Tooth Dec 5	2
	6158727900	Warning Label for sanding	1
		Guard 7"	1

OPTIONAL ACCESSORIES

Sanding with spiracool pad Ø7" (180mm)

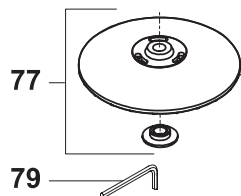

Item	Part no.	Description	Qty
77	S091836	Spiracool Pad (max speed 8500rpm)	1
79	6158020610	Hex key 5/16"	1

Backing pad M14 & 5/8"

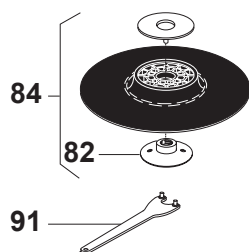

Item	Part no.	Description	Qty
84	6159901330	Soft Backing Pad 7" with nut M14 & 5/8" (max speed 8500rpm)	1
84	6159901340	Rigid Backing Pad 7" with nut M14 & 5/8" (max speed 8500rpm)	1
82	606.22	Nut M14	1
82	608.29	Nut 5/8"	1
91	6158020100	Pin Wrench 1-3/8"	2

M14

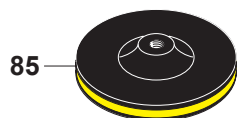

Item	Part no.	Description	Qty
85	6159901450	Rigid velcro-backed backing pad 7" (max speed 8500rpm)	1
85	6159901370	Rigid velcro-backed backing pad 6" (max speed 10000rpm)	1

5/8"

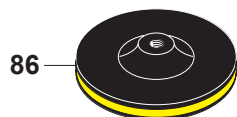

Item	Part no.	Description	Qty
86	6159901460	Rigid Velcro-backed Backing pad 7" (max speed 8500rpm)	1
86	6159901380	Rigid velcro-backed Backing pad 6" (max speed 10000rpm)	1