



BOSCH

Laser Level

GLL 3-80 | 3 601 K63 310

Table of Content

Spare parts list.....	2
Illustration - Type.....	3

Spare parts list

Item	Part Number	Description	Illustration
5	1 618 C00 325	Casing Foot	1
6	1 618 C00 326	Casing Foot	1
7	1 618 C01 699	Casing Foot	1
12	2 610 A14 334	Type Label	1
13	1 618 C00 354	Adhesive Label	1
21	1 618 C01 774	Window	1
22/15	1 618 C01 773	Window	1
22/5	1 618 C00 12T	Switch Slide	1
22/7	1 618 C01 752	Nut	1
25	1 618 C01 707	Battery Cover	1

Illustration - Type - E

3 601 K63 300
Stand } 13-12
Issue } 14-02-27

Fig./Abb. 1

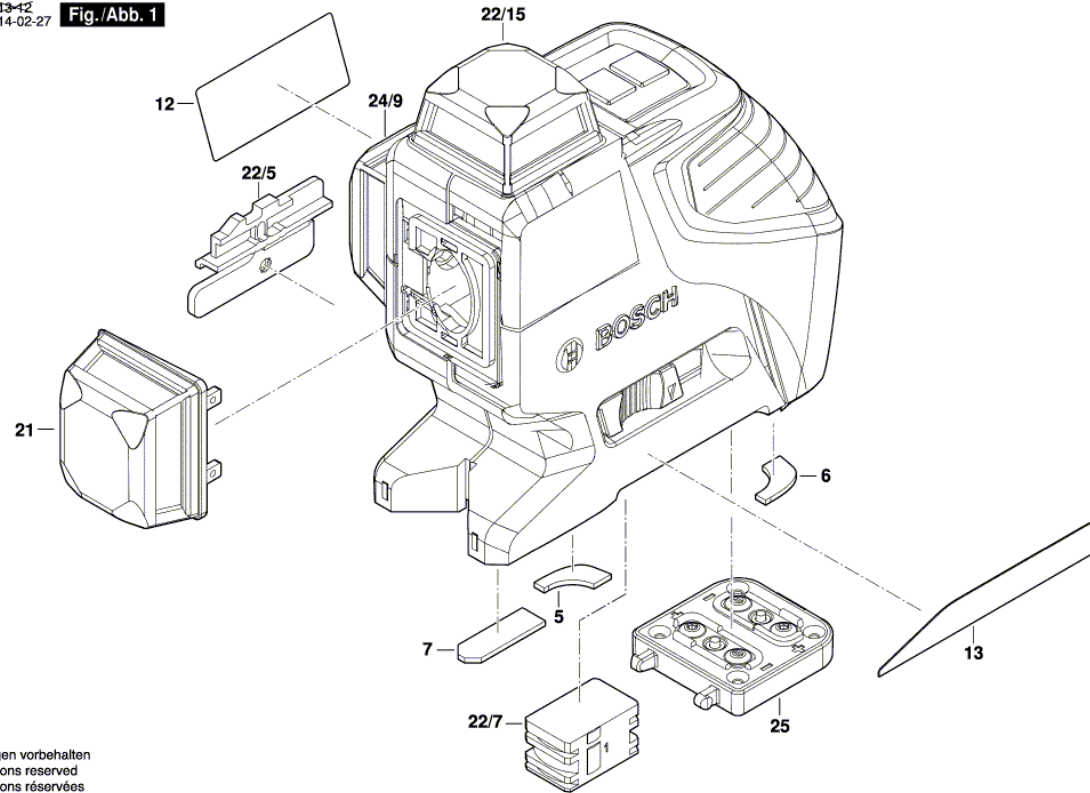

Änderungen vorbehalten
Modifications reserved
Modifications réservées
Salvo modificaciones