



BOSCH

Laser Level

GPL2 | 3 601 K66 711

Table of Content

Spare parts list.....	2
Illustration - Type.....	3

Illustration - Type - E

3801 K66 210
Issue | 08-11-25
Stand } **Fig./Abb. 1**

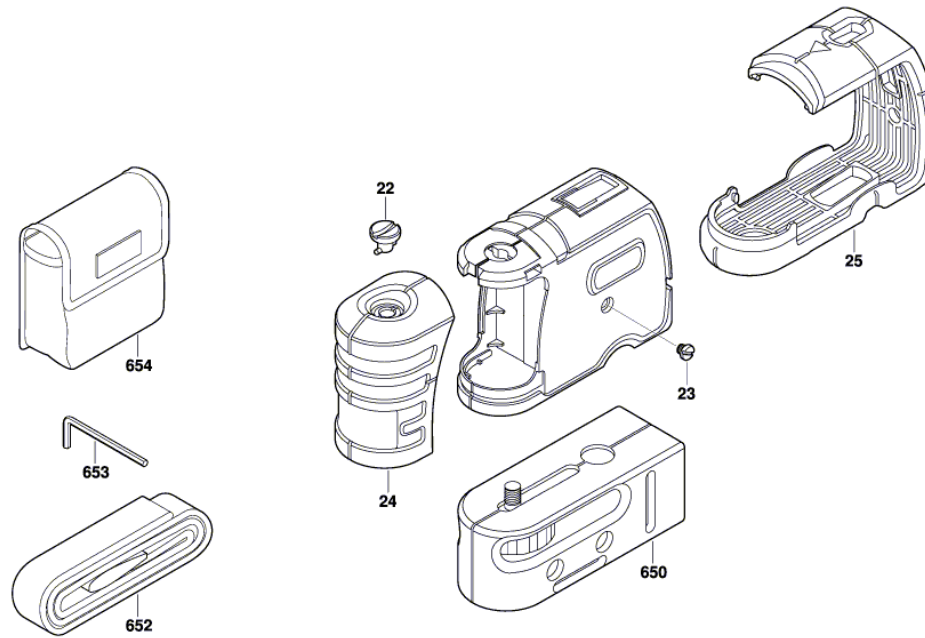

Modifications reserved
Änderungen vorbehalten
Modifications réservées
Salvo modificaciones