



BOSCH

High Frequency Drill

GR.55 | 0 602 120 006

Table of Content

Spare parts list.....	2
Illustration - Type.....	4

Spare parts list

Item	Part Number	Description	Illustration
2	1 600 209 011	Seal Ring	1
3	1 604 229 201	Stator 200V/300HZ,135V/200HZ	1
4	1 600 502 005	Air-Deflector Ring	1
5	3 604 080 020	Rotor	1
5/3	1 606 610 105	Fan	1
6	1 900 900 232	groove ball bearing 5x16x5	1
7	3 600 206 002	Rubber Ring 6MM,Ø12xØ16,4x3MM	1
8	1 900 905 036	groove ball bearing 609 RSY/C3 DIN 625	1
9	3 605 820 006	Bearing Housing	1
9/3	3 600 300 002	Bushing	1
11	1 900 210 146	O-Ring 45x3MM	1
13	1 901 091 012	Socket-Terminal Strip 1x1,5 MM/2	1
14	1 607 200 040	On-Off Switch	1
14/1	2 910 091 082	Pan head screw DIN 85-M3,5x6-4.8	1
14/2	2 916 060 004	Spring Washer A 3,5 DIN 137-ST	1
16	3 600 703 011	Grommet Ø9,2-Ø12x120 MM	1
17	1 601 302 014	Fastening Clamp	1
18	3 605 132 072	Handle	1
20	3 605 806 034	Spindle Bearing	1
20/2	3 600 300 008	Bushing	1
20/3	2 917 500 122	Straight Pin 4H 8x20 DIN 7	1
21	3 603 124 002	Drilling Spindle 3/8"-24 UNF-2	1
22	1 900 905 100	groove ball bearing 6000 Z DIN 625	1
23	2 916 650 001	Spring retaining ring DIN 471-10x1MM-FSt	1
24	2 600 108 031	Sealing disk	1
25	3 603 344 013	Threaded Ring M 28x1 MM LEFTHAND THREADS	1
26	1 606 319 017	Cylindrical Gear Z=27	1
27	2 600 100 613	Shim 0,50 MM	1
28	1 606 328 094	Spindle With Gear Z=21/27	1
30	3 601 106 053	Nameplate	1
31	3 603 133 000	Grooved Nail	1
33	3 601 321 001	Clamping Saddle	1
33/1	2 916 010 409	Plain Washer DIN 46 255-DPG 9	1
34	3 600 150 006	Spring Washer Ø4,2 MM	1

Spare parts list

Item	Part Number	Description	Illustration
35	2 910 110 120	Pan head screw DIN 85-AM4x10-MS	1
40	2 910 021 116	Socket head cap screw DIN 84-AM4x6-8.8	1
41	2 910 091 118	Pan head screw DIN 85-AM4x8-4.8	1
42	2 910 211 019	Tapping Screw DIN 7971-ST3,9x16-F	1
43	2 910 011 128	Socket head cap screw DIN 84-AM4x18-5.8	1
44	2 910 141 136	Hex Socket Head Cap Screw DIN 912-M 4x35-8.8	1
46	3 603 402 000	Set screw	1
47	2 910 011 115	Socket head cap screw DIN 84-AM4x5-5.8	1
800	3 605 102 022	Motor Housing	1

Illustration - Type - E

Typ 0 602 120 0 . .

Stand } 90-06
Issue }

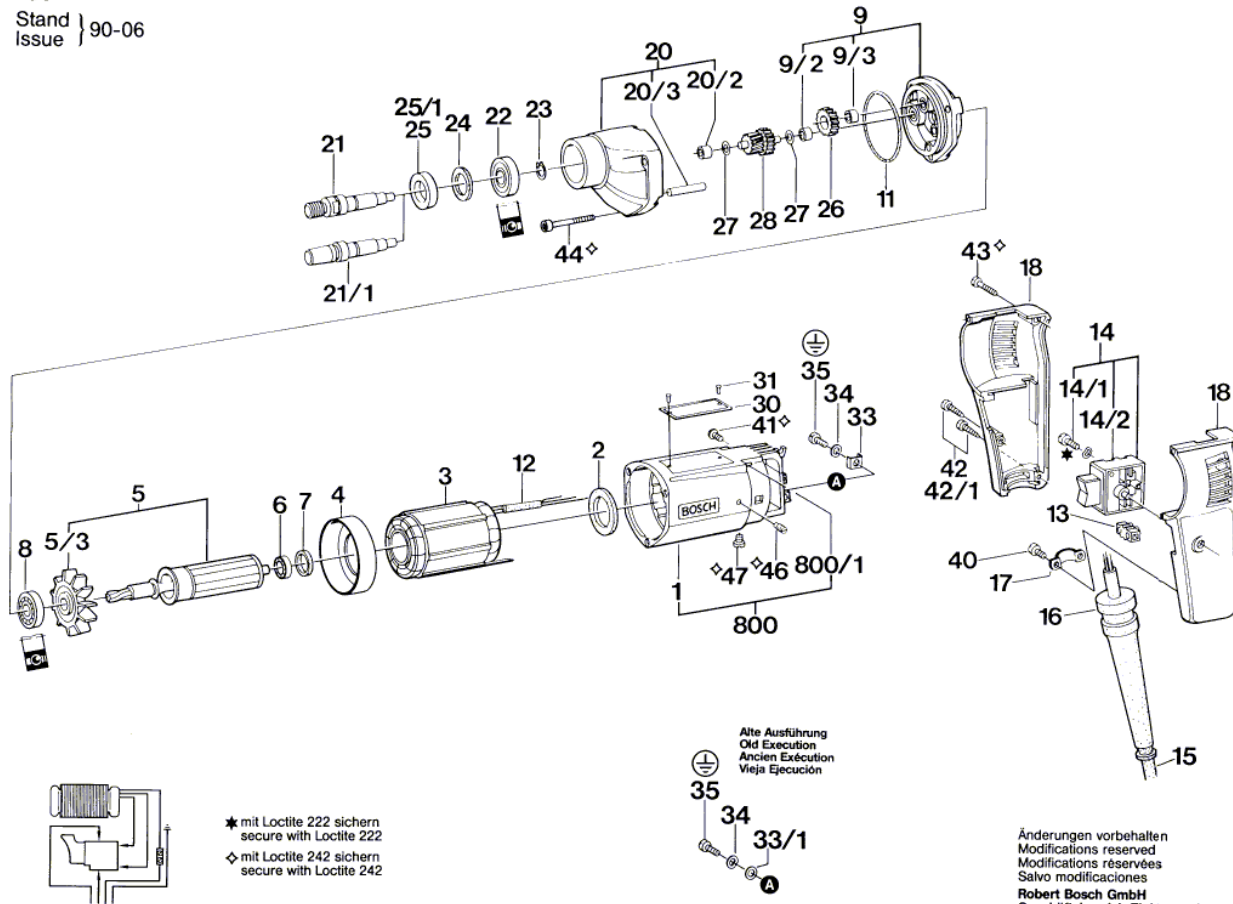

0 602 120 001