

# TRU-POWER, INC.

Product Line **GENERAL PURPOSE ENGINE**  
 Type **N5AF**

Model Name **GSV190A**

Mfg

Section **ENGINE**

Illustration

**CYLINDER BARREL**

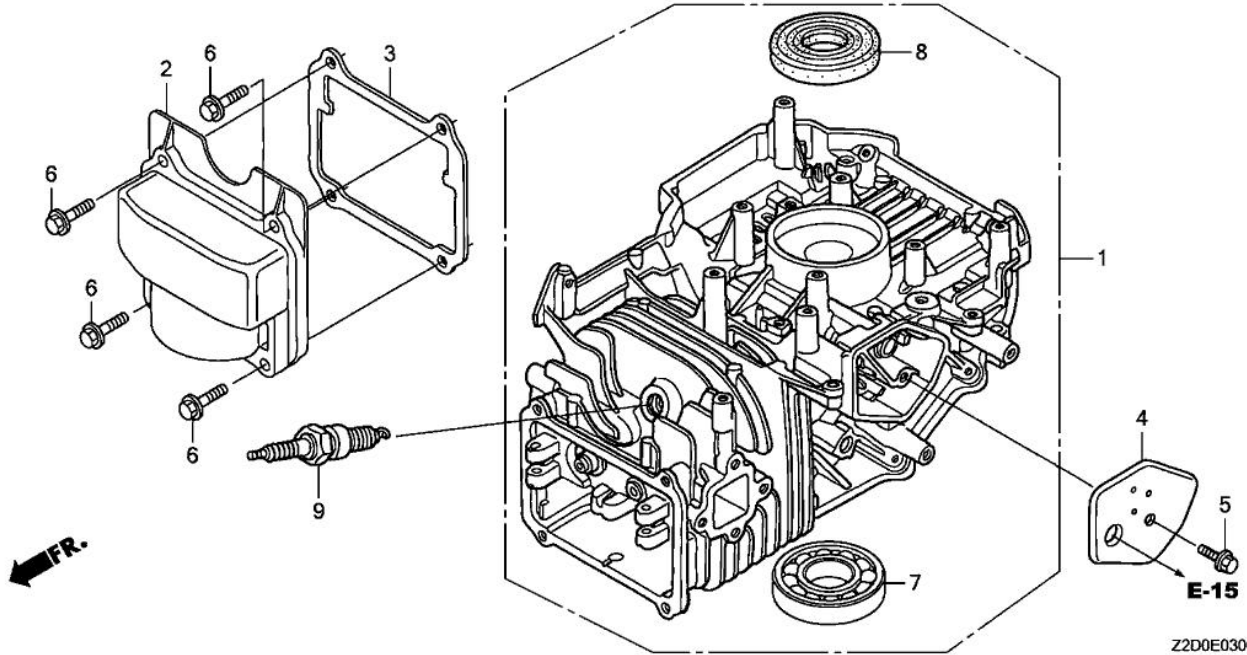

Ref.	Part Number	Part Description	Qty.
001	12000-Z2C-000	CYLINDERASSY.	001
002	12311-Z2A-000	COVER, CYLINDER HEAD	001
003	12312-Z2A-000	GASKET, HEAD COVER	001
004	12355-ZL8-000	COVER, BREATHER (BREATHER VALVE ASSY.)	001
005	90014-952-000	BOLT, FLANGE (6X14) (CT200)	001
006	90121-952-000	BOLT, FLANGE (6X25) (CT200)	004
007	91001-894-004	BEARING, RADIAL BALL	001
008	91201-Z2A-003	OIL SEAL (25.4X74X6)	001
009	98079-56846	SPARK PLUG (BPR6ES) (NGK)	001

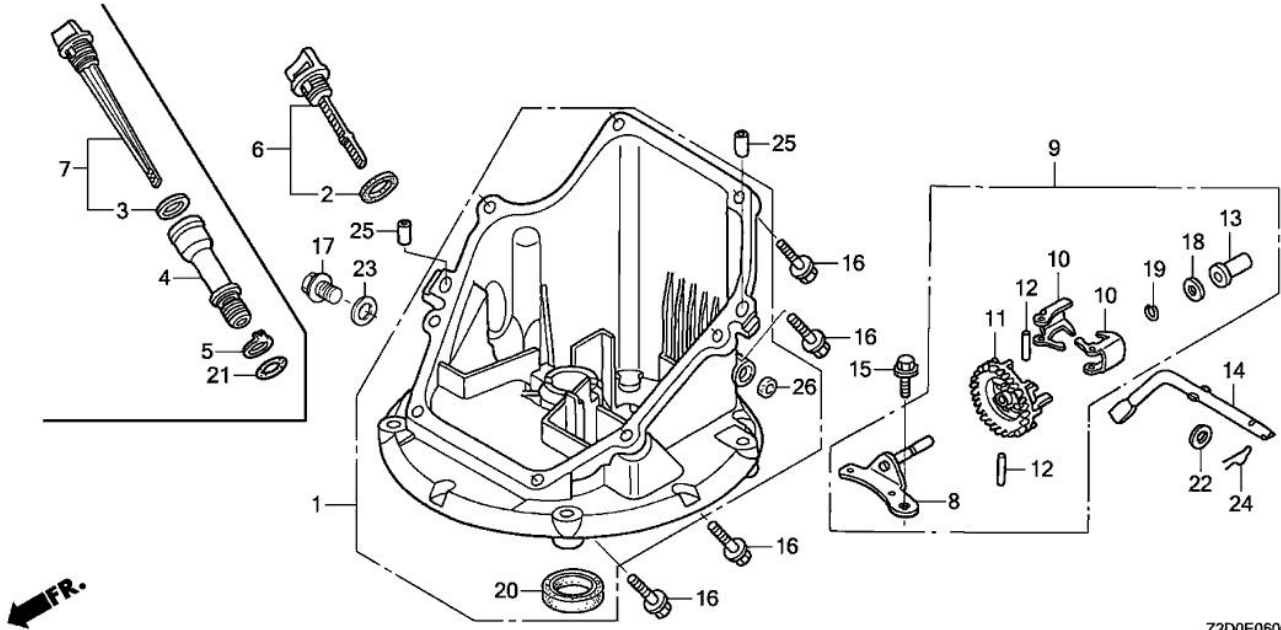

Z2D0E0600B

Ref.	Part Number	Part Description	Qty.
001	11300-Z0L-821	PAN ASSY., OIL (SAE)	001
002	15625-Z2L-801	GASKET, OIL FILLER CAP	001
006	15650-Z0L-000	GAUGE ASSY., OIL LEVEL	001
008	16508-ZM0-010	SHAFT, GOVERNOR HOLDER	001
009	16510-ZM0-010	GOVERNOR ASSY.	001
010	16511-ZL8-000	WEIGHT, GOVERNOR	002
011	16512-ZM0-000	HOLDER, GOVERNOR WEIGHT	001
012	16513-ZE1-000	PIN, GOVERNOR WEIGHT	002
013	16531-ZE1-000	SLIDER, GOVERNOR	001
014	16541-ZM0-000	SHAFT, GOVERNOR ARM	001
015	90014-952-000	BOLT, FLANGE (6X14) (CT200)	001
016	90121-952-000	BOLT, FLANGE (6X25) (CT200)	008
017	90131-896-650	BOLT, DRAIN PLUG (12X15)	001
018	90451-ZE1-000	WASHER, THRUST (6MM)	001
019	90602-ZE1-000	CLIP, GOVERNOR HOLDER	001
020	91202-ZM0-V31	OIL SEAL (28X41.25X6) (NOK)	001
022	94101-06800	WASHER, PLAIN (6MM)	001
023	94109-12000	WASHER, DRAIN PLUG (12MM)	001
024	94251-08000	PIN, LOCK (8MM)	001
025	94301-08200	PIN, DOWEL (8X20)	002

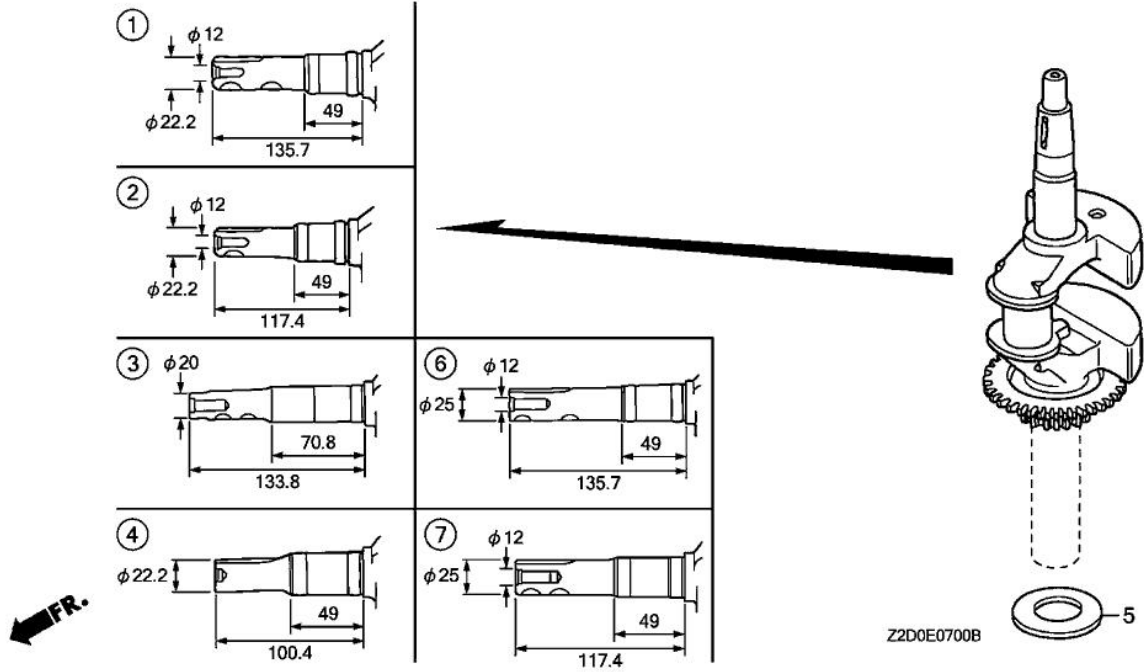

Ref.	Part Number	Part Description	Qty.
004	13310-Z0Y-650	CRANKSHAFT	001
005	90402-ZL8-000	WASHER, THRUST	001

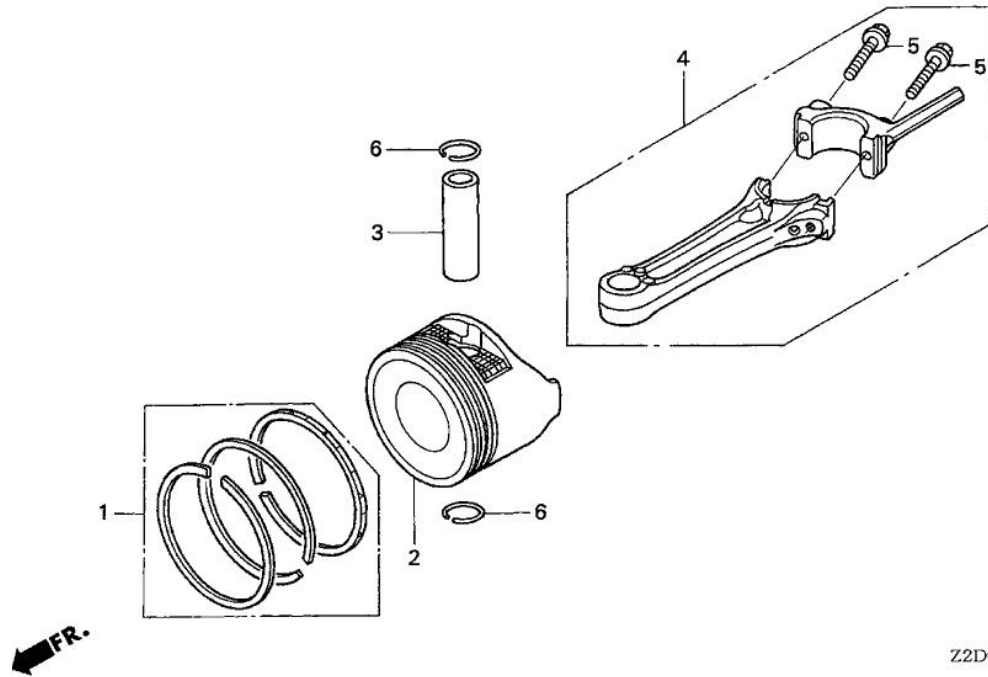

Z2D0-E0800

Ref.	Part Number	Part Description	Qty.
001	13010-Z2C-004	RING SET, PISTON (STD) (TEIKOKU)	001
001	13010-Z2C-014	RING SET, PISTON (STD) (TEIKOKU)	001
002	13101-Z0Y-000	PISTON	001
002	13101-Z8D-820	PISTON	001
003	13111-Z0Y-000	PIN, PISTON	001
004	13200-Z0Y-000	ROD ASSY., CONNECTING	001
004	13200-Z0Y-010	ROD ASSY., CONNECTING	001
005	90001-ZE1-000	BOLT, CONNECTING ROD	002
006	90551-ZE0-000	CLIP, PISTON PIN (13MM)	002

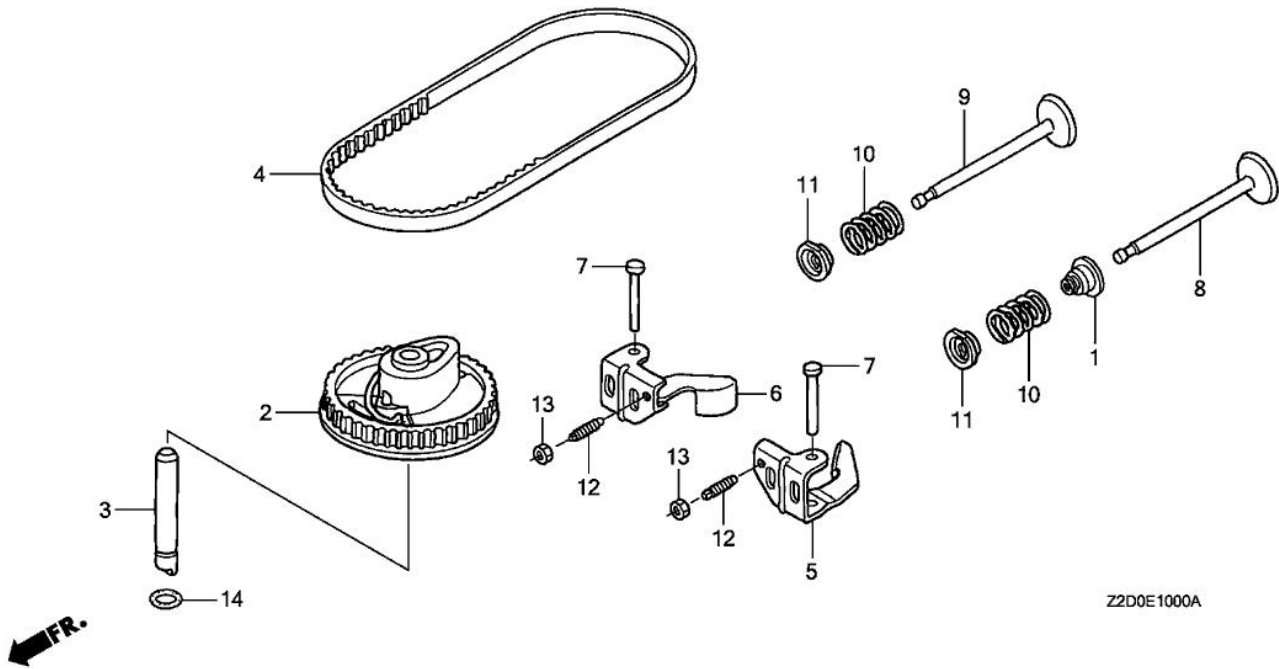

Z2D0E1000A

Ref.	Part Number	Part Description	Qty.
001	12209-ZM0-003	SEAL, VALVE STEM	001
002	14320-Z0Y-000	PULLEY, CAMSHAFT	001
002	14320-Z8D-000	PULLEY, CAMSHAFT	001
003	14324-ZL8-000	SHAFT, CAM PULLEY	001
004	14400-Z0J-014	BELT, TIMING (84HU7 G-200)	001
004	14400-Z8B-003	BELT, TIMING (84HU6 G-200)	001
005	14431-Z0J-000	ARM, IN. VALVE ROCKER	001
006	14441-Z0J-000	ARM, EX. VALVE ROCKER	001
007	14461-ZL8-000	SHAFT, ROCKER ARM	002
008	14711-Z0J-000	VALVE, IN. (ROCKNEL)	001
008	14711-ZL8-000	VALVE, IN. (TECHNOSTAR)	001
009	14721-ZL8-000	VALVE, EX. (L8E)	001
009	14721-Z8B-000	VALVE, EX. (C8E)	001
010	14751-ZL8-000	SPRING, VALVE	002
011	14771-ZE1-000	RETAINER, IN. VALVE SPRING	002
012	90012-333-000	SCREW, TAPPET ADJUSTING	002
013	90206-001-000	NUT, TAPPET ADJUSTING	002
014	91301-ZM0-V31	O-RING (6.8X1.9) (ARAI)	001

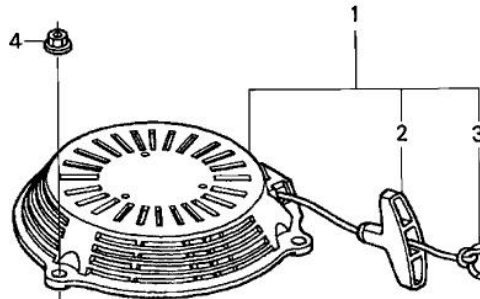

Z2D0-E1100

Ref.	Part Number	Part Description	Qty.
001	28400-Z1A-013ZA	STARTER ASSY., RECOIL *NH1*(BLACK)	001
001	28400-Z1A-013ZB	STARTER ASSY., RECOIL *R280*(POWER RED)	001
002	28461-ZL8-003	GRIP, STARTER	001
003	28462-ZL8-003	ROPE, RECOIL STARTER	001
004	90201-ZM0-000	NUT, FLANGE (6MM)	003

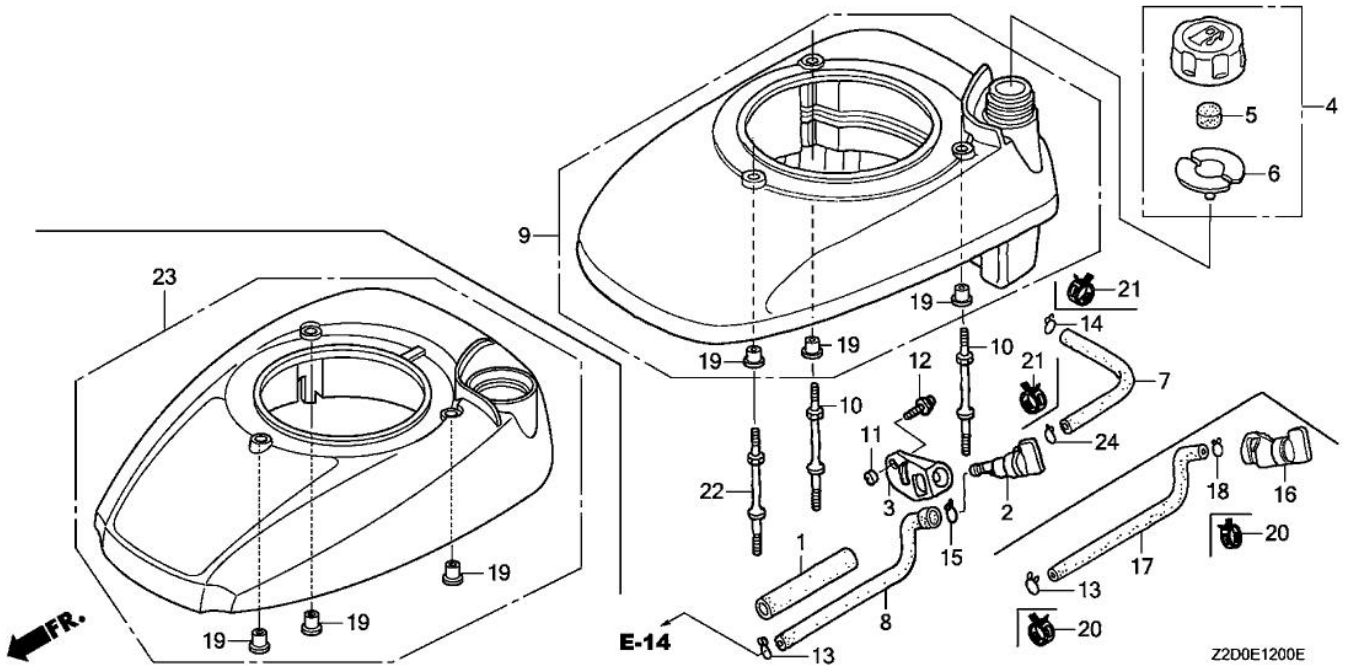

Ref.	Part Number	Part Description	Qty.
001	16854-ZH8-000	RUBBER, SUPPORTER (107MM)	001
002	04103-Z0L-000	KIT FUEL COCK TUBE	001
003	16956-ZG9-M00	BRACKET, PETCOCK	001
003	16956-ZM0-000	BRACKET, PETCOCK	001
004	17620-ZL8-013	CAP ASSY., FUEL TANK	001
004	17620-ZL8-023	CAP ASSY., FUEL TANK	001
005	17622-ZL8-003	SPONGE, FUEL CAP BREATHER	001
006	17624-ZL8-013	GASKET, FUEL CAP	001
007	17701-Z0L-000	TUBE, FUEL TANK	001
008	17702-ZM0-000	TUBE, FUEL	001
009	19610-Z0L-000ZA	COVER, FAN *NH1*(BLACK)	001
009	19610-Z0L-000ZD	COVER, FAN *R280*(POWER RED)	001
010	90043-ZL8-000	BOLT, STUD (H=42.5MM)	002
011	91501-Z0L-800	COLLAR, FUEL PETCOCK	001
012	93891-05010-08	SCREW-WASHER (5X10)	001
013	95002-02080	CLIP, TUBE (B8)	001
014	95002-02100	CLIP, TUBE (B10)	001
015	95002-50000	CLIP, TUBE (C9)	001
019	19619-ZL8-300	COLLAR, FAN COVER	003
022	90043-ZL8-000	BOLT, STUD (H=42.5MM)	001
024	95002-02100	CLIP, TUBE (B10)	001

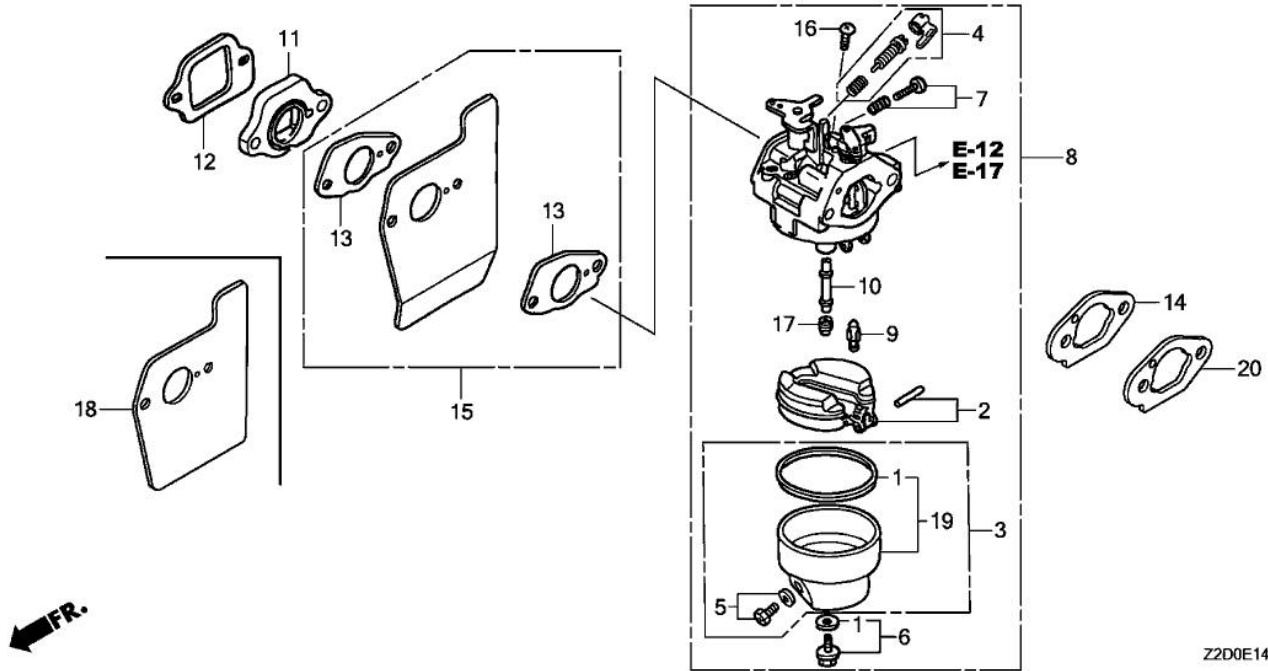

Z2D0E1400D

Ref.	Part Number	Part Description	Qty.
001	16010-883-015	GASKET SET	001
002	16013-ZL1-003	FLOAT SET	001
003	16015-887-782	CHAMBER SET, FLOAT (CARBURETOR NO.)	001
004	16016-ZG0-W00	SCREW SET (CARBURETOR NO.)	001
005	16024-ZE1-811	SCREW SET, DRAIN (CARBURETOR NO.)	001
006	16028-ZE0-005	SCREW SET	001
006	16028-ZK7-S91	SCREW SET	001
007	16029-ZG0-901	SCREW SET (THROTTLE STOP) (CARBURETOR NO.)	001
008	16100-Z2D-813	CARBURETOR ASSY. (BB65G C)	001
009	16155-ZM0-003	VALVE, FLOAT (CARBURETOR NO.)	001
009	16155-ZM0-013	VALVE, FLOAT (CARBURETOR NO.)	001
010	16166-Z0Y-003	NOZZLE, MAIN	001
011	16211-ZL8-000	INSULATOR, CARBURETOR	001
012	16212-ZL8-000	GASKET, INSULATOR	001
013	16221-883-800	GASKET, CARBURETOR	002
014	16228-ZL8-000	GASKET, CARBURETOR	001
015	19650-ZM0-000	GUIDE, AIR	001
016	93500-05006-0H	SCREW, PAN (5X6)	001
017	99101-124-0620	JET, MAIN (#62)	001
017	99101-124-0650	JET, MAIN (#65)	(1)
017	99101-124-0680	JET, MAIN (#68)	001
018	19651-Z0L-000	GUIDE, AIR	001
019	16015-Z0L-881	CHAMBER SET, FLOAT (CARBURETOR NO.)	001



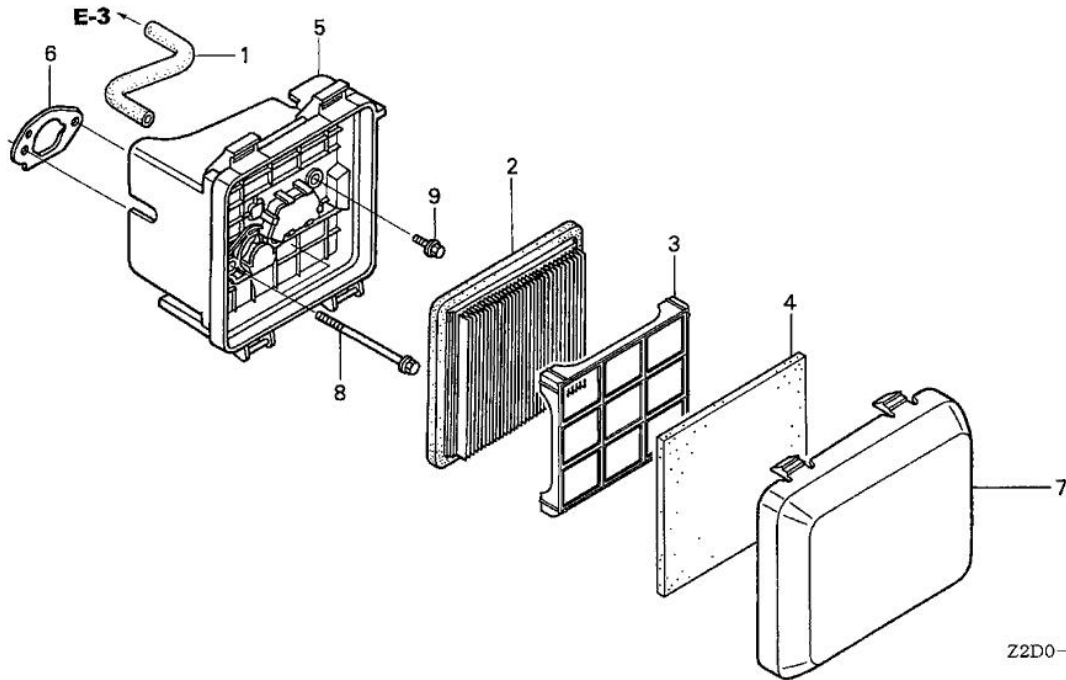

Z2D0-E1500

Ref.	Part Number	Part Description	Qty.
001	15721-ZM0-000	TUBE, BREATHER	001
002	17211-ZL8-023	ELEMENT, AIR CLEANER (TOYO ROKI)	001
003	17212-Z2A-010	GRID, AIR CLEANER	001
004	17218-Z2A-000	FILTER (OUTER) (WET)	001
005	17220-ZM0-000	CASE ASSY., AIR CLEANER	001
005	17220-ZM0-010	CASE ASSY., AIR CLEANER	001
005	17220-ZM0-020	CASE ASSY., AIR CLEANER	001
006	17228-ZM0-000	GASKET, AIR CLEANER	001
007	17231-Z2B-020	COVER, AIR CLEANER (DUAL)	001
008	90003-ZM0-010	BOLT, FLANGE (6X85) (CT200)	002
009	95701-06014-08	BOLT, FLANGE (6X14)	001

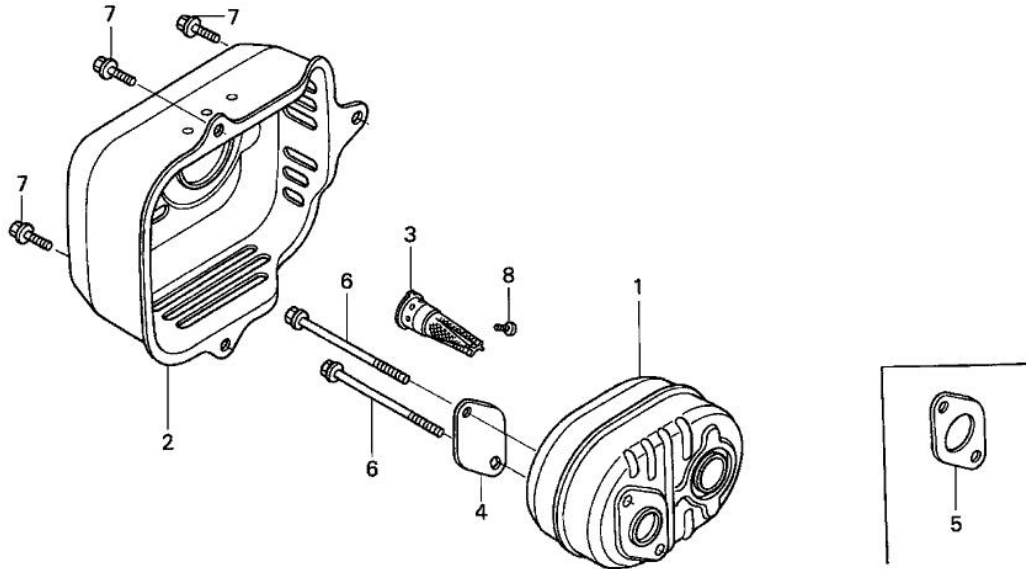

Z2D0-E1600

Ref.	Part Number	Part Description	Qty.
001	18310-Z0Y-000	MUFFLER	001
002	18321-Z0L-010	PROTECTOR, MUFFLER	001
003	18350-ZL8-000	ARRESTER, SPARK	(1)
004	18356-ZL8-000	PLATE, ARRESTER NUMBER	(1)
005	18381-ZL8-305	GASKET, MUFFLER	(1)
006	90004-ZL8-000	BOLT, FLANGE (6X79) (CT200)	002
007	90013-883-000	BOLT, FLANGE (6X12) (CT200)	003
008	90055-ZE1-000	SCREW, TAPPING (4X6)	(1)

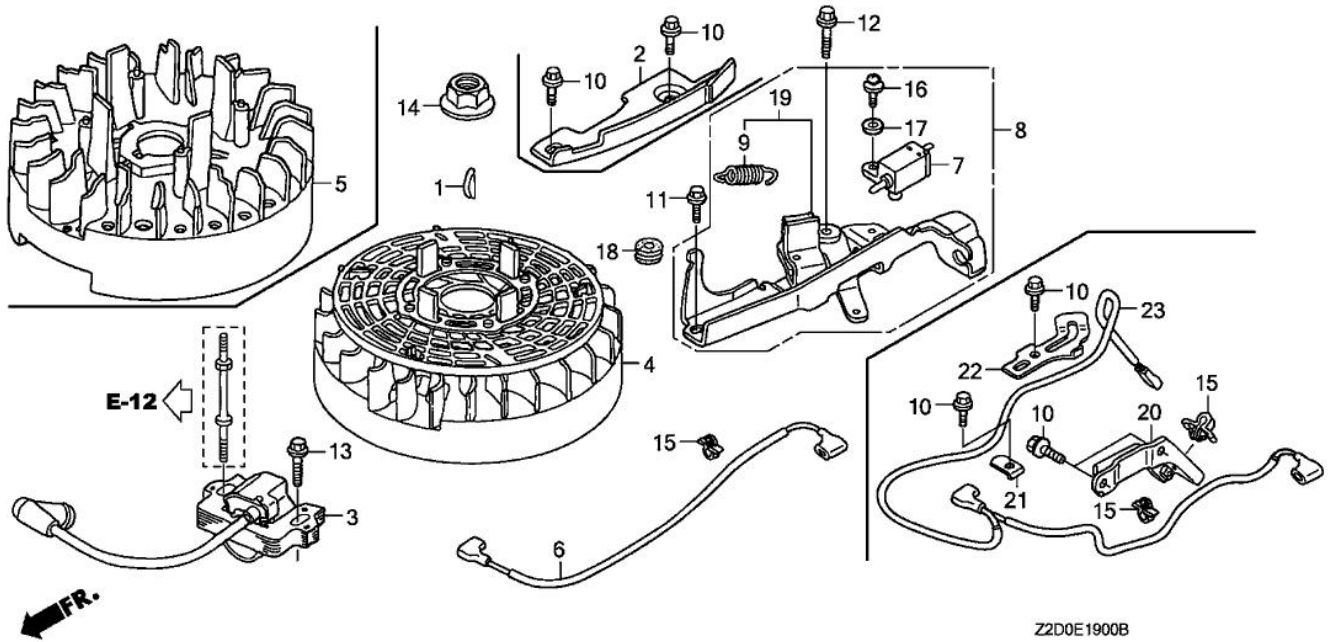

Ref.	Part Number	Part Description	Qty.
001	13331-357-000	KEY, SPECIAL WOODRUFF (25X18)	001
002	19612-Z0L-000	PLATE, SIDE	001
003	30500-Z0J-003	COIL ASSY., IGNITION (PHELON) (USE FOR F/W OF PHELON)	001
003	30500-Z8B-901	COIL ASSY., IGNITION (PHELON)	001
005	31110-Z0J-013	FLYWHEEL COMP. (PHELON) (USE FOR IGN. COIL OF PHELON)	...
010	90013-883-000	BOLT, FLANGE (6X12) (CT200)	002
013	90022-888-010	BOLT, FLANGE (6X20) (CT200)	001
014	90213-S3Y-000	NUT, FLANGE (14MM)	001

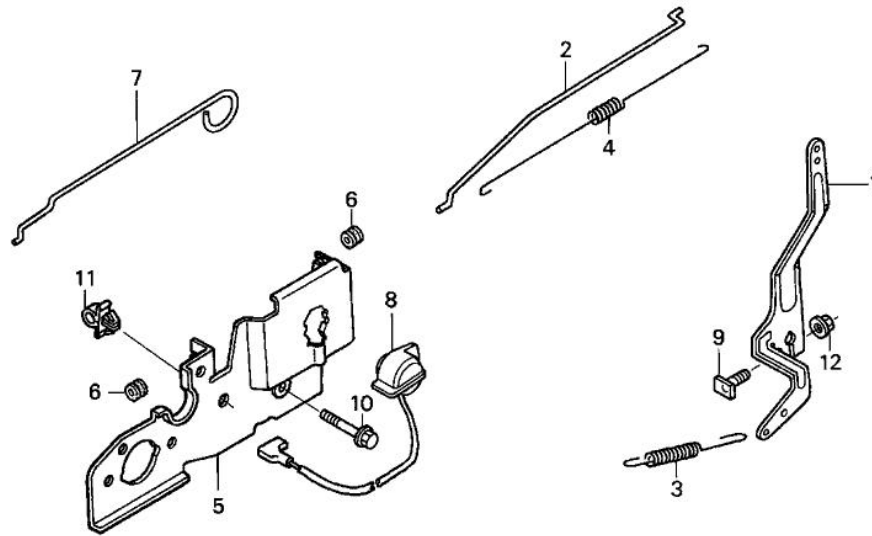

FR.

Z2D0 E2203

Ref.	Part Number	Part Description	Qty.
001	16551-ZM0-010	ARM, GOVERNOR	001
002	16555-Z0L-800	ROD, GOVERNOR	001
002	16555-Z0L-801	ROD, GOVERNOR	001
003	16561-ZM0-V30	SPRING, GOVERNOR	001
004	16562-ZM0-000	SPRING, THROTTLE RETURN	001
005	16580-Z0L-800	BASE, CONTROL	001
006	16613-893-000	GROMMET, CHOKE ROD	002
007	16674-Z0L-800	ROD, CHOKE	001
008	35120-Z0L-801	SWITCH ASSY., ENGINE STOP	001
009	90015-ZE5-010	BOLT, GOVERNOR ARM	001
010	90016-ZE8-000	BOLT, FLANGE (6X45) (CT200)	001
011	90681-959-003	CLIP A, CABLE (3.8MM BLACK) (NIFCO)	001
012	94050-06000	NUT, FLANGE (6MM)	001

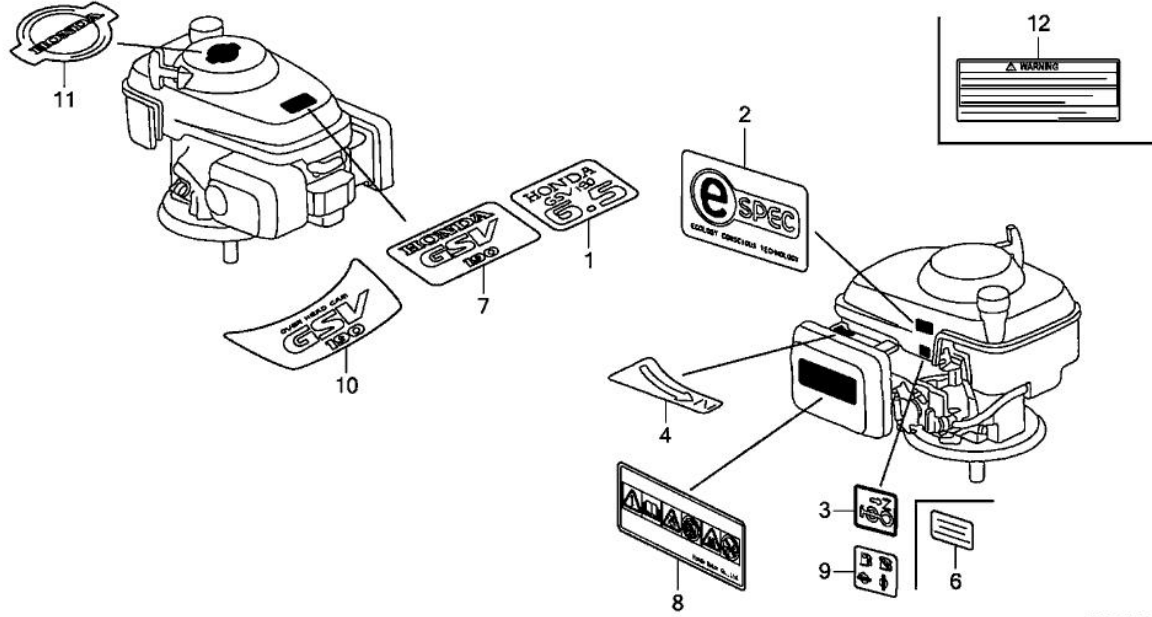

Z2D0E2800G

Ref.	Part Number	Part Description	Qty.
001	87101-Z2D-000	MARK, EMBLEM (GSV190 6.5)	001
003	87528-ZL8-000	MARK, CHOKE	001
006	87114-ZH7-821	LABEL, WARNING (NOT CERTIFIED FOR SALE)	(NOT CERTI... 001