

16032 Water Packing Kit

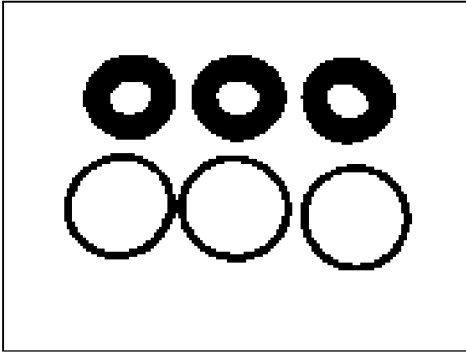

16029 Unloader Set Kit

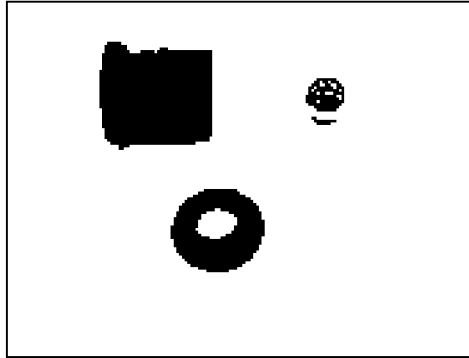

16026 Valve Kit

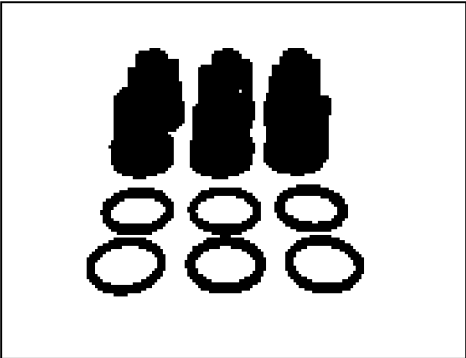

16030 Unloader Stem Kit

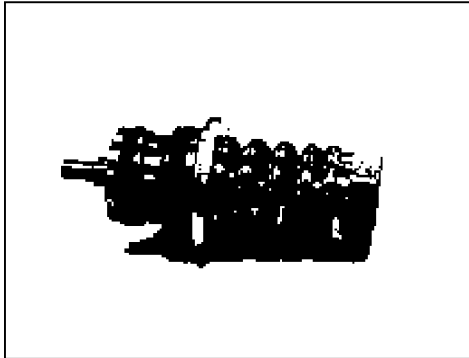

16027 Unloader Check Kit

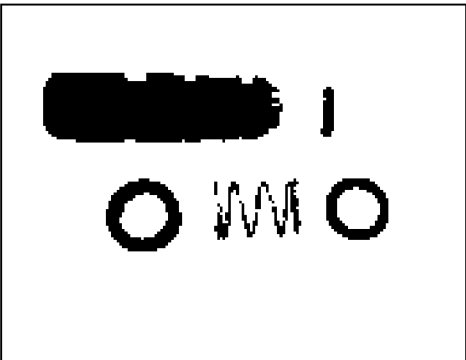

16028 Injector Repair Kit

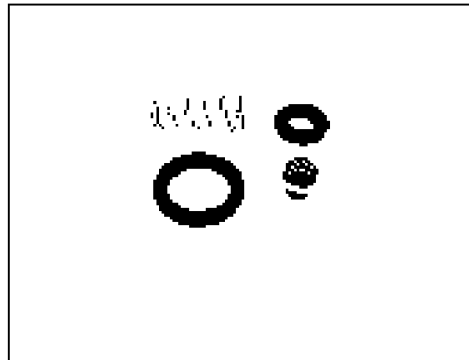

16031 Manifold Assy.

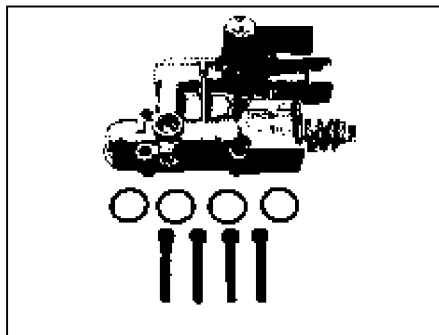

Parts List for WGV1518 Type 0

Item Number	Part Number	Description	Qty Required
1	000000-00	No Longer Available	1
2	5140026-07	KIT VALVE	1
3	5140026-08	KIT UNLOADER CHECK	1
4	000000-00	No Longer Available	1
5	5140026-06	KIT UNLOADER STEM	1
6	FA-50381300	KIT CHEMICAL INJECTO	1
7	000000-00	No Longer Available	1
8	FA-57136300	EXTENSION INLET	1
9	FA-57136200	EXTENSION OUTLET	1
10	000000-00	No Longer Available	1
11	FA-57136300	EXTENSION INLET	1
12	000000-00	No Longer Available	1
13	17658	VALVE THERMAL RELIEF	1
14	FA-57137400	CAP OIL FILL	1
15	FA-15065600	O-RING	1
16	FA-57015402	VALVE ASSEMBLY OIL V	1
17	FA-57137400	CAP OIL FILL	1
18	FA-52036700	BODY CHEMICAL INJECT	1
19	FA-15000600	O-RING 7.66 X 1/78 N	1
20	000000-00	No Longer Available	1
21	FA-15060500	ORING 15 X 2 FAIP	1
22	FA-15000100	O-RING	1
23	FA-10205200	SCREW	1
24	F187	SCREEN GARDEN HOSE 3	1
25	FA-15001500	O-RING	1
501	000000-00	No Longer Available	1
502	17658	VALVE THERMAL RELIEF	1

Parts List for WGV1518 Type 0

Item Number	Part Number	Description	Qty Required
503	000000-00	No Longer Available	1
504	15294	KEY	1
505	D23215	OIL SAE 10W-30 SJ 32	1
506	000000-00	No Longer Available	1
507	000000-00	No Longer Available	1
508	000000-00	No Longer Available	1
509	15972	CAP	2
510	000000-00	No Longer Available	2
511	17709	TIRE SEMI 8 X 2.25	2
512	W137	NUT .50 PAL	2
513	000000-00	No Longer Available	1
514	F064	SCREW .313-18X1.00 H	1
515	488860-00	FLAT WASHER	1
516	16087	NUT .313-18 UNC FLAN	3
517	000000-00	No Longer Available	3
518	000000-00	No Longer Available	3
519	H040	HOSE 1/4 X 25 2500PS	1
520	000000-00	No Longer Available	1
521	D27703	GUN .25 FLARE 2700PS	1
522	A11371	HOSE ASSY	1
523	000000-00	No Longer Available	1
524	NCT001	TOOL NOZZLE CLEANING	1
525	16797	WRENCH ALLEN 2MM	1